



CATALOGO 2018

# ALUBOX

Cassette Postali - Mailboxes

RISTAMPA  
settembre 2019

 **ALUBOX** è specializzata nella produzione di cassette postali singole, casellari postali componibili, bacheche porta chiavi, porta avvisi e pulsantiere in ottone. Fondata nel 1976 con il nome di Trimec, nel 1990, i suoi fondatori, abili progettisti di stampi per lamiera, decisero di vendere le proprie azioni agli attuali soci e nacque **ALUBOX**.

La capacità di proporre continuamente prodotti innovativi e di presentarsi sul mercato con programmi di vendita moderni, hanno portato l'azienda ad un rapido sviluppo commerciale consentendole di raggiungere la leadership sul mercato italiano.

Questa crescita importante ha determinato grandi investimenti anche nella struttura operativa, rendendo necessario l'acquisto di nuovi locali destinati agli uffici e al magazzino e il potenziamento dei macchinari e degli stampi per realizzare articoli sempre più rispondenti alle esigenze di mercato ed in conformità con le normative europee **EN13724**.

In questa prospettiva di crescita e sviluppo si è dato ampio spazio all'introduzione di nuovi modelli e colorazioni per le cassette singole e importanti innovazioni sono state realizzate anche sulla serie **MODULAR**, inserendo serie sempre più moderne dallo standard qualitativo alto e dal design evoluto, come la **nuova Serie SLIM**, capace di soddisfare molte esigenze contenendo il prezzo.

Negli ultimi anni **ALUBOX** si è introdotta con successo anche nel settore della Grande Distribuzione Organizzata, diventando un punto di riferimento per le maggiori catene di negozi, sapendo scegliere i giusti prodotti da proporre e investendo così su un mercato specializzato e costantemente in espansione.

L'attenzione dedicata al prodotto ed alle esigenze diverse di mercato, ha consentito nel tempo di identificare il marchio **ALUBOX** con un'immagine di originalità ed esclusività offrendo un buon rapporto qualità/prezzo.

 *Alubox is specialised in the production of single mailboxes, mailbox sets, notice boards, key stands, holders and intercom pushbutton panels. It was established in 1976 as TRIMEC and in 1990 the founders decided to sell their own stakes to the current shareholders and so **ALUBOX** was born.*

*The constant development of production, resulting from the company's ability to continuously offer innovative products and present itself on the market with modern sales strategies, has enabled **ALUBOX** to attain leadership on Italian market.*

*The continuous growth has also led to major investments in the operational structures: in addition to acquiring new office facilities and buildings to house productions and logistic processes, the company has upgraded its machineries and dies in order to produce articles increasingly in line with market demands and in accordance with European standard rules **EN 13724**.*

*By this philosophy of development process, the company studied new models and different finishes for single mailboxes together with important innovations for **Modular** range such as **CURVE** Series and **new Slim Series**, capable to meet many needs through high quality and modern design.*

***ALUBOX** is very well introduced in the channel of ironmonger shops, DIY stores and the channel of building.*

*The regard to the product and to different needs of the market allowed to identify **ALUBOX** brand by original and exclusive image, offering a good quality / price ratio.*

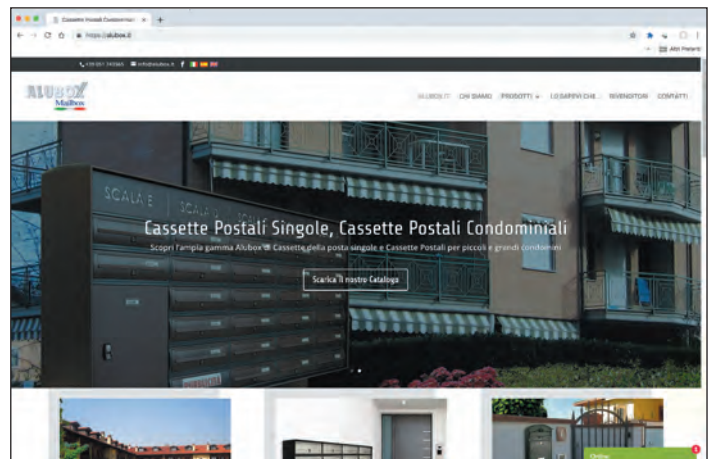
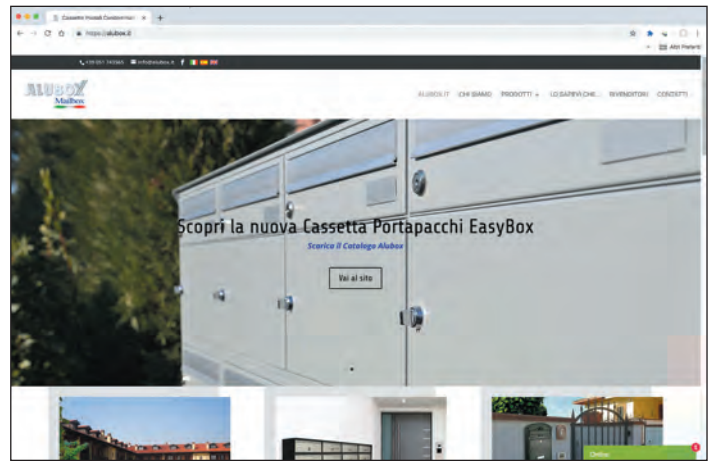

[www.alubox.it](http://www.alubox.it)

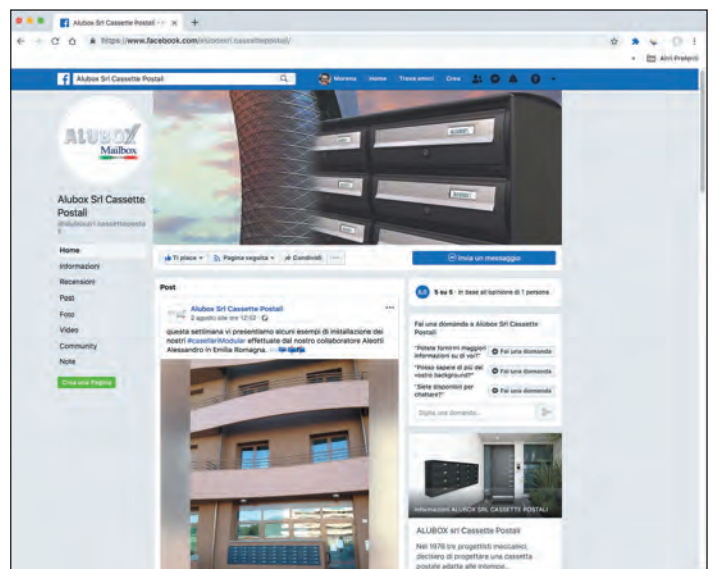

Alubox Srl Cassette Postali

**ALUBOX** s.r.l.  
Cassette Postali - Mailboxes  MADE IN ITALY

40065 Pianoro - BO - via Boaria, 5  
tel. 051 743 565 - fax 051 744 010  
info@alubox.it



**CASSETTE E CASELLARI POSTALI  
CONDOMINIALI** *PAG. 4 - 57*

*COMPOSTE PER ESTERNI*

Casellari **slim** *pag. 4 - 9*

Serie Jumbo Lux - Jumbo *pag. 10 - 12*

*COMPOSTE PER INTERNI - ESTERNI PROTETTI*

Serie Cubo *pag. 12 - 13*

*SINGOLE COMBINIBILI*

Serie Esse *pag. 14*

*COMBINIBILI PER ESTERNI*

**Serie MODULAR - CURVE** *pag. 15 - 47*

Serie Curve *pag. 18 - 21*

Serie Modular *pag. 22 - 37*

**ACCESSORI:**

Piantane di supporto *pag. 38 - 39*

Mantelli di rivestimento *pag. 40*

Cornici da incasso *pag. 41*

Componenti per videocitofonia *pag. 42 - 47*

Esempi di installazione *pag. 48 - 58*

**CASSETTE POSTALI SINGOLE** *PAG. 59 - 84*

**CASSETTE POSTALI PERSONALIZZABILI  
Porta Chiavi e Porta Zampironi** *PAG. 60 - 67*

Serie MIA *pag. 60 - 63*

Porta Chiavi *pag. 64*

Porta Spirali Antizanzara *pag. 65 - 67*

Cassette postali singole *pag. 68 - 81*

**MAILBOXES AND MAILBOX SETS  
FOR CONDOMINIUM** *PAGE 4 - 57*

*COMPOSED MAILBOXES FOR OUTDOORS*

**slim** Mailbox Sets *page 4 - 11*

Jumbo Lux - Jumbo Series *page 10 - 12*

*COMPOSED MAILBOXES FOR INDOORS-SHELTERED LOCATION*

Cubo Series *page 12 - 13*

*SINGLE COMBINABLE MAILBOXES*

Esse Series *page 14*

*COMBINABLE MAILBOXES FOR OUTDOORS*

**MODULAR - CURVE Series** *page 15 - 47*

Curve Series *page 18 - 21*

Modular Series *page 22 - 37*

**ACCESSORIES:**

Support columns *page 38 - 39*

Outer casing *page 40*

Recess frames *page 41*

Intercom accessories *page 42 - 47*

Example of installations *page 48 - 58*

**SINGLE MAILBOXES** *PAGE 59 - 84*

**CUSTOM MAILBOXES - Key Stands  
and Spiral Holders Anti-Mosquitos** *PAGE 60 - 67*

MIA Series *page 60 - 63*

Key Stands *page 64*

Spiral Holders Anti-Mosquitos *page 65 - 67*

Single mailboxes *page 68 - 81*



**CASSETTE PORTAPACCHI** **PARCEL BOXES**

PAG. - PAGE 82 - 83 - 84

**new**

**PaccoBox**





Cassetta porta pane	pag. 84
Coprifertoio	pag. 85
Raccogliposta	pag. 85
Sportelli e Frontali	pag. 86
Combi	pag. 87
Accessori per cassette postali	pag. 87
Porta Pubblicità	pag. 88 - 90

Bread box	page 84
Slot flaps	page 85
Mail collection box	page 85
Front plates and doors	page 86
Combi	page 87
Accessories for mailboxes	page 87
Box for publicity	page 88 - 90

**SERIE OTTONE** *PAG. 91 - 100*

**BRASS SERIES** *PAG. 91 - 100*



Cassette e Frontali in Ottone	pag. 92 - 94
Sportelli da incasso	pag. 95
Coprifertoio	pag. 95
Targhe	pag. 96
Numeri Civici	pag. 96
Campanelli	pag. 97
Pulsantiere	pag. 98 - 99
Campane	pag. 100
Campanelle da banco	pag. 100
Porta lettere	pag. 100

Brass mailboxes and Front plates	page 92 - 94
Recess doors	page 95
Slot flaps	page 95
Residence number plates	page 96
Residence numbers	page 96
Doorbells	page 97
Bell plates	page 98 - 99
Bells	page 100
Desk bells	page 100
Desktop letters	page 100



**le cose di ALUBOX** *PAG. 101 - 106*

Numeri Resinati Adesivi	pag. 102
Posacenere da Muro e da Terra	pag. 103
Bacheche Porta Avvisi	pag. 104
Bacheche Porta Chiavi	pag. 105
Lucchetto	pag. 106
Appenditutto	pag. 106

Adhesive numbers	page 102
Ashtrays	page 103
Key boards	page 104
Key stands	page 105
Portable safety box	page 106
Universal hanger	page 106

Esempi Espositivi Personalizzati	pag. 107 - 109
Angoli e pareti espositive	pag. 110 - 111
Colori di Serie	pag. 112
Agenti	pag. 112
Condizioni di vendita	pag. 112

Examples of Customized Layout	page 107 - 109
Exhibition corner and walls	page 110 - 111
Standard Colours	page 112
Agents for Italy	page 112
Sales terms	page 112

# slim

MODELLO CONFORME  
NORMA EUROPEA  
EN 13724

# new

MADE IN ITALY

## ALTA QUALITÀ, PREZZO "SOTTILE" HIGH QUALITY, "SLIM" PRICE

SLIM è il nuovo casellario postale da esterno adatto ad ogni tipo di installazione. Mantiene tutti i pregi dei nostri casellari postali MODULAR contenendo il prezzo senza rinunciare a un'altissima qualità.

SLIM is a new mailbox set for outdoors suitable to every kind of installations. SLIM maintains very high quality of our MODULAR system with lower price.

### Le caratteristiche principali di SLIM:

- 100% MADE IN ITALY
- tenuta all'acqua garantita
- pronta consegna
- grande capacità contenitiva
- rispondente alle normative EN13724
- viene fornito completamente assemblato
- sportello costruito in profilato di alluminio con sistema antiprelievo
- corpo cassetta interamente verniciato
- mantello di rivestimento verniciato alle polveri su entrambi i lati
- nessuna parte del casellario è soggetta alla corrosione, in quanto trattata con vernice alle polveri a processo di lavorazione concluso.
- verniciatura alle polveri color argento metallizzato e verniciato grigio antracite
- prelievo della posta frontale
- composizioni disponibili a 3, 4, 5, 6, 8, 9, 10, 12, 15, 16, 18 e 20 posti

### Main features of SLIM :

- 100% MADE IN ITALY
- water resistant warranty
- prompt delivery
- magazine format
- SLIM is in compliance with EN13724
- it's supplied already assembled
- aluminium profile front door with antivandal system
- the body is completely painted
- outer casing is epoxy powder painted on both sides
- no parts of the mailbox set is exposed to corrosion due to the epoxy powder painted treatment at the end of manufacturing process
- metallic silver and anthracite color epoxy powder paint
- front access only
- bank available with 3, 4, 5, 6, 8, 9, 10, 12, 15, 16, 18 and 20 units

La nuova Serie **slim** è disponibile con il mantello verniciato Argento o Grigio Antracite.

New **slim** series is available with outer casing in Silver or Anthracite finish.



Con il mantello ghisa è possibile avere lo sportello in tutte le varianti colore dello sportello Modular.

**N.B.** Le cornicette di plastica del corpo cassetta sono sempre colore grigio antracite.

If You choose outer casing in anthracite color finish, doors are available in every colors of Modular doors.

**Please note:** plastic frame of mailbox body is always in anthracite finish.



SP1AR



SP1BI



SP1BR



SP1GH



SP1VE/el. mob.  
grigio antracite



SP1RO/el. mob.  
grigio antracite



SP1OTT con elemento mobile in ottone  
SP1OTT with polished brass flap



Esempio con sportelli rossi.  
Example with red doors.



SP1PUB con kit pubblicità (vedi pag. 38)  
SP1PUB with publicity kit (see page 38)

Grande capacità contenitiva  
Magazine format

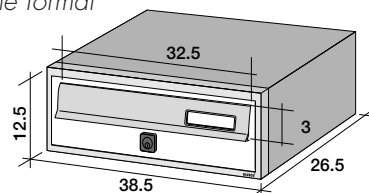

Sistema antiprelievo  
Antivandal system

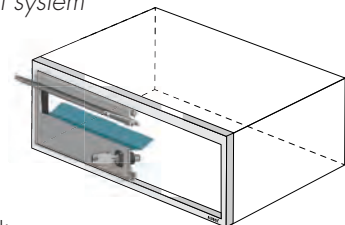

Piantane di supporto:  
Support columns:

PICCOLA  
Small

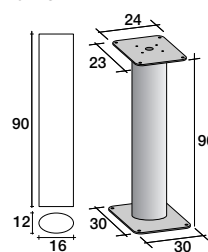

GRANDE  
Big

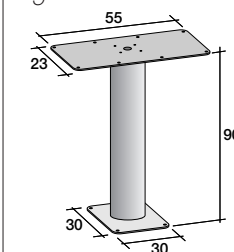

Installazioni possibili: - Possible installations:

- 1 - fissaggio a muro - wall mounting
- 2 - incasso a muro - recess mounting
- 3 - passante su infisso - through the window
- 4 - fissaggio su cancellata - fence installation
- 5 - passante su cancellata - through the fence
- 6 - su piantana autoportante - freestanding with support columns

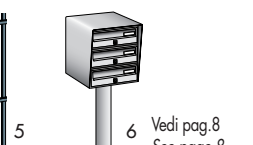
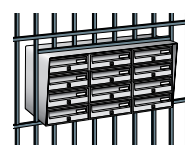
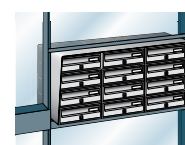
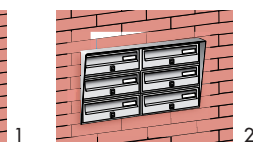
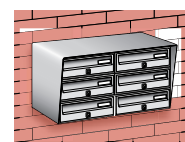

Vedi pag. 8  
See page 8

# slim 3x1 Casellario postale da esterno a 3 posti - Mailbox set for outdoors 3 units

MADE IN ITALY

Esterno formato RIVISTA COMPOSTO MODELLO CONFORME EN 13724



Esempio Slim con sportelli verdi.  
Example of Slim with green doors.

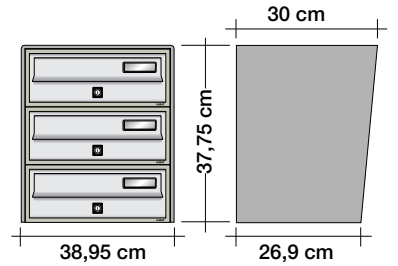

Per installazione autoportante: 1 piantana piccola.  
For freestanding installation: 1 small column.

# slim 4x1 Casellario postale da esterno a 4 posti - Mailbox set for outdoors 4 units

MADE IN ITALY

Esterno formato RIVISTA COMPOSTO MODELLO CONFORME EN 13724



Esempio Slim con sportelli argento.  
Example of Slim with silver doors.

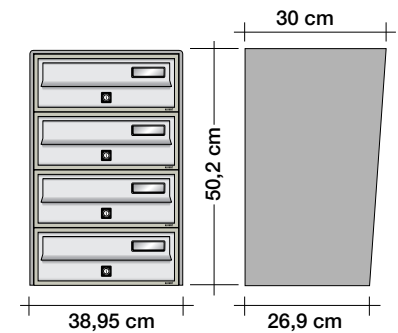

Per installazione autoportante: 1 piantana piccola.  
For freestanding installation: 1 small column.

# slim 5x1 Casellario postale da esterno a 5 posti - Mailbox set for outdoors 5 units

MADE IN ITALY

Esterno formato RIVISTA COMPOSTO MODELLO CONFORME EN 13724



Esempio Slim con sportelli bronzo.  
Example of Slim with bronze doors.

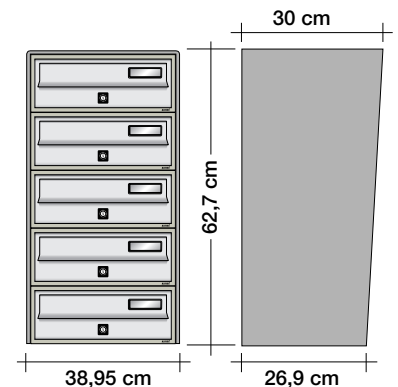

Per installazione autoportante: 1 piantana piccola.  
For freestanding installation: 1 small column.

# slim 3x2

## Casellario postale da esterno a 6 posti - Mailbox set for outdoors 6 units

MADE IN ITALY

Esterno formato RIVISTA COMPOSTO MODELLO CONFORME EN 13724



Esempio Slim con sportelli rossi e kit pubblicità.  
Example of Slim with red doors and publicity kit.

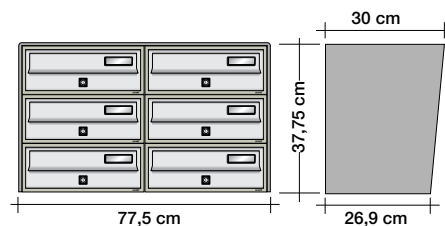

Per installazione autoportante: 1 piantana grande.  
For freestanding installation: 1 big column.

# slim 4x2

## Casellario postale da esterno a 8 posti - Mailbox set for outdoors 8 units

MADE IN ITALY

Esterno formato RIVISTA COMPOSTO MODELLO CONFORME EN 13724



Esempio Slim con sportelli bianchi.  
Example of Slim with white doors.

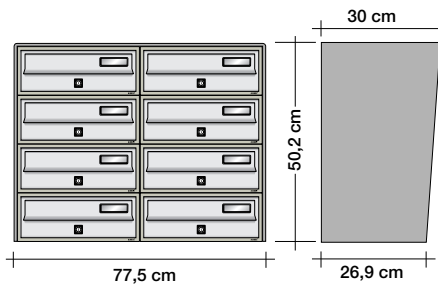

Per installazione autoportante: 1 piantana grande.  
For freestanding installation: 1 big column.

# slim 3x3

## Casellario postale da esterno a 9 posti - Mailbox set for outdoors 9 units

MADE IN ITALY

Esterno formato RIVISTA COMPOSTO MODELLO CONFORME EN 13724



Esempio Slim con sportelli grigio antracite con elemento mobile ottone.  
Example of Slim with anthracite color doors and polished brass flap.

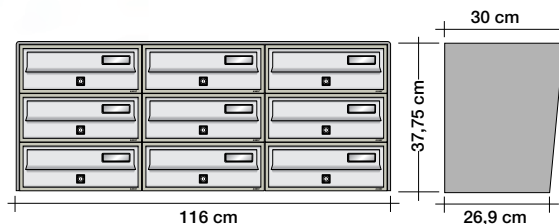

Per installazione autoportante: 1 piantana grande.  
For freestanding installation: 1 big column.

# slim 5x2

## Casellario postale da esterno a 10 posti - Mailbox set for outdoors 10 units

MADE IN ITALY

Esterno formato RIVISTA COMPOSTO MODELLO CONFORME EN 13724

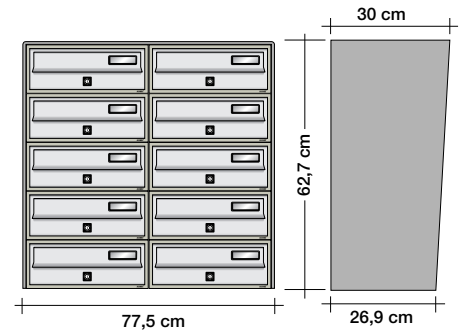

Esempio Slim con sportelli argento.  
Example of Slim with silver doors.

Per installazione autoportante: 1 piantana grande.  
For freestanding installation: 1 big column.

# slim 4x3

## Casellario postale da esterno a 12 posti - Mailbox set for outdoors 12 units

MADE IN ITALY

Esterno formato RIVISTA COMPOSTO MODELLO CONFORME EN 13724



Esempio Slim con sportelli bronzo.  
Example of Slim with bronze doors.

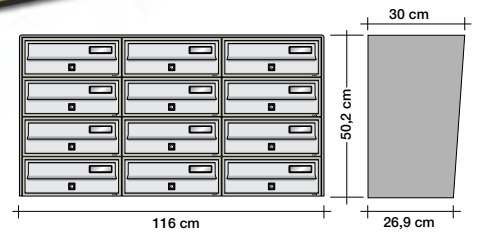

Per installazione autoportante: 1 piantana grande.  
For freestanding installation: 1 big column.

# slim 5x3

## Casellario postale da esterno a 15 posti - Mailbox set for outdoors 15 units

MADE IN ITALY

Esterno formato RIVISTA COMPOSTO MODELLO CONFORME EN 13724



Esempio Slim con sportelli verdi.  
Example of Slim with green doors.

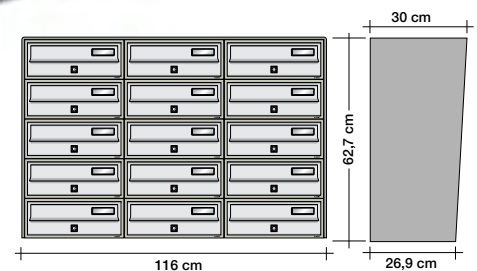

Per installazione autoportante: 1 piantana grande.  
For freestanding installation: 1 big column.



# slim 4x4

## Casellario postale da esterno a 16 posti - Mailbox set for outdoors 16 units

MADE IN ITALY

Esterno formato RIVISTA COMPOSTO MODELLO CONFORME EN 13724



Esempio Slim con sportelli rossi.  
Example of Slim with red doors.

Per installazione autoportante: 2 piantane grandi.  
For freestanding installation: 2 big columns.

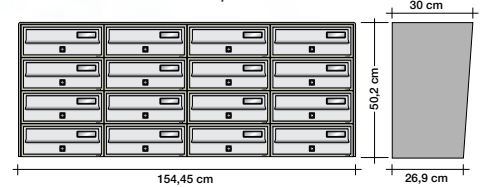

# slim 6x3

## Casellario postale da esterno a 18 posti - Mailbox set for outdoors 18 units

MADE IN ITALY

Esterno formato RIVISTA COMPOSTO MODELLO CONFORME EN 13724



*new*



Esempio Slim con sportelli grigio antracite con elemento mobile ottone.  
Example of Slim with anthracite color doors and polished brass flap.

Per installazione autoportante: 1 piantane grandi.  
For freestanding installation: 1 big columns.

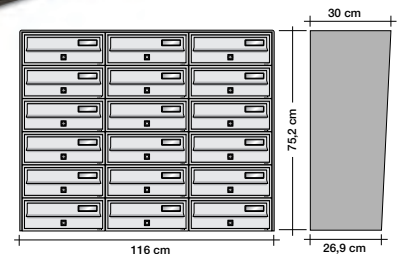

# slim 5x4

## Casellario postale da esterno a 20 posti - Mailbox set for outdoors 20 units

MADE IN ITALY

Esterno formato RIVISTA COMPOSTO MODELLO CONFORME EN 13724



Esempio Slim con sportelli argento.  
Example of Slim with silver doors.

Per installazione autoportante: 2 piantane grandi.  
For freestanding installation: 2 big columns.

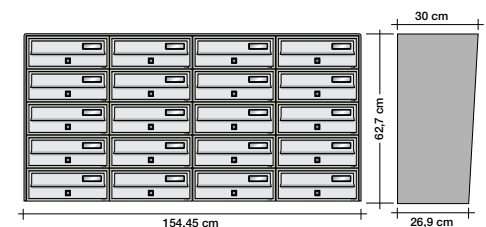

# slim Esempi di installazione - Examples of installation

MADE IN ITALY



**SLIM 3x1** su piantana autoportante. **SLIM 3x1** freestanding installation.



**SLIM 4x1** passante su infisso. **SLIM 4x1** through the window installation.



**SLIM 4x4** fissato a muro. **SLIM 4x4** wall mounting installation.



**SLIM 3x2** incassato a parete. **SLIM 3x2** recess mounting installation.



**SLIM 3x3** su piantana autoportante. **SLIM 3x3** freestanding installation.



**SLIM 5x4** su piantane autoportanti. **SLIM 5x4** freestanding installation.



**SLIM 6x3** passante su recinzione. **SLIM 6x3** through fence installation.



**SLIM 4x2** fissato a recinzione. **SLIM 4x2** fence installation.

# Serie\*JUMBO LUX 1 *ad esaurimento*



J05LUX1



## Ritiro frontale

(confezione da 1 pezzo)

### PER ESTERNO - FORMATO RIVISTA

Corpo in lamiera elettrozincata verniciata alle polveri colore grigio antracite e sportello SP1 completo di elemento mobile in profilato d'alluminio. Corpo perforato sui lati per unione di più casellari.

- anodizzato argento
- anodizzato bronzo
- verniciato grigio antracite
- verniciato bianco
- verniciato rosso con elemento mobile grigio antracite
- verniciato verde con elemento mobile grigio antracite
- **SP - OTT** con elemento mobile in ottone.

## Front access

(1-piece package)

### OUTDOORS - MAGAZINE FORMAT

Electrogalvanized sheet steel body, anthracite color epoxy powder painted, matt finish. Aluminium profile SP1 door with flap. Predisposed for assembly of several mailbox units.

- anodized - silver
- anodized - bronze
- painted - anthracite color
- painted - white
- painted - red, with anthracite color flap
- painted - green, with anthracite color flap
- **SP - OTT** door with brass flap.

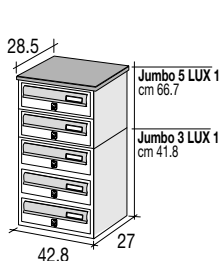
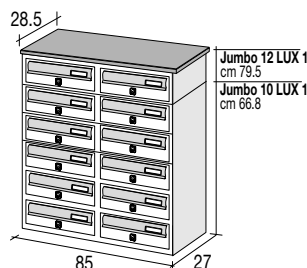
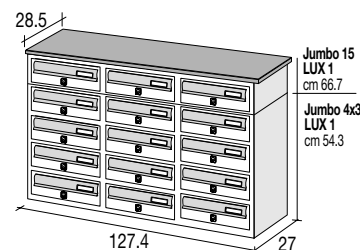
 Jumbo 5 LUX 1  
cm 66.7  
Jumbo 3 LUX 1  
cm 41.8

 Jumbo 12 LUX 1  
cm 79.5  
Jumbo 10 LUX 1  
cm 66.8

 Jumbo 15 LUX 1  
cm 66.7  
Jumbo 4x3 LUX 1  
cm 54.3

# Serie\*JUMBO LUX 2 *ad esaurimento*

 J03LUX2  
Fronte  
Front view

 J03LUX2  
Retro  
Rear view

## Ritiro posteriore

(confezione da 1 pezzo)

### PER ESTERNO - FORMATO RIVISTA

Corpo in lamiera elettrozincata verniciata alle polveri colore grigio antracite e sportello SP2 completo di elemento mobile in profilato d'alluminio. Corpo perforato sui lati per unione di più casellari.

- anodizzato argento
- anodizzato bronzo
- verniciato grigio antracite
- verniciato bianco
- verniciato rosso con elemento mobile grigio antracite
- verniciato verde con elemento mobile grigio antracite
- **SP - OTT** con elemento mobile in ottone.

## Rear access

(1-piece package)

### OUTDOORS - MAGAZINE FORMAT

Electrogalvanized sheet steel body, anthracite color epoxy powder painted, matt finish. Aluminium profile SP2 door with flap. Predisposed for assembly of several mailbox units.

- anodized - silver
- anodized - bronze
- painted - anthracite color
- painted - white
- painted - red, with anthracite color flap
- painted - green, with anthracite color flap
- **SP - OTT** door with brass flap.

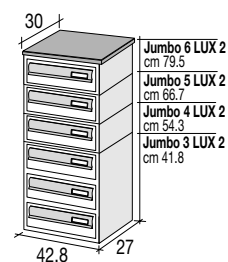
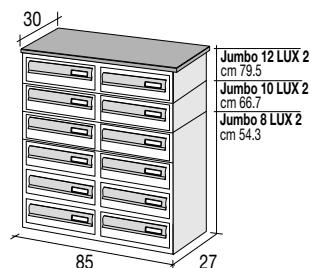
 Jumbo 6 LUX 2  
cm 79.5  
Jumbo 5 LUX 2  
cm 66.7  
Jumbo 4 LUX 2  
cm 54.3  
Jumbo 3 LUX 2  
cm 41.8

 Jumbo 12 LUX 2  
cm 79.5  
Jumbo 10 LUX 2  
cm 66.7  
Jumbo 8 LUX 2  
cm 54.3

Tutti i modelli Jumbo LUX1 e Jumbo LUX2 sono accessoriabili con citofono, campanelli e telecamera della Serie Bricino Sfera e New Sfera (vedi da pag. 42).

All Jumbo LUX1 and Jumbo LUX2 models can be provided with intercom, doorbells and video camera for Bricino Sfera and New Sfera Series (see page 42).

Tutti i modelli Jumbo LUX possono essere montati con la piantana standard Modular (vedi a pag. 38).

All Jumbo LUX models can be mounted with Modular support column (see page 38)

# Serie\*JUMBO

I modelli Jumbo 3, 4 e 5 montano gli sportelli della Modular 1 (SP1), vedi a pag. 23.  
Non abbinabile al JUMBO 6/8/10

*Jumbo 3, 4, 5 models need SP1 doors (see page 23).*

*Not assemble together with 6/8/10 models.*

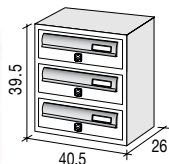

**JUMBO 3**  
Blocchiera da 3 cassette  
3 unit mailbox set

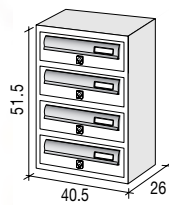

**J4RO**  
**JUMBO 4**  
Blocchiera da 4 cassette  
4 unit mailbox set



**J5AR**  
**JUMBO 5**  
Blocchiera da 5 cassette  
5 unit mailbox set

I modelli Jumbo 6, 8 e 10 montano gli sportelli della Modular 270 (SP1270/1), vedi a pag. 33.  
Non abbinabile al JUMBO 3/4/5

*Jumbo 6, 8, 10 models need SP1/270 doors (see page 33).*

*Not assemble together with 3/4/5 models.*



**J6BR**



**J8AR**



**J10RO**

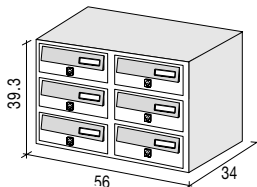

**JUMBO 6**  
Blocchiera da 6 cassette  
6 unit mailbox set

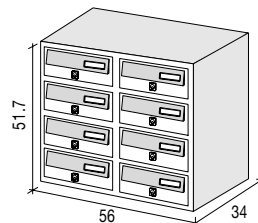

**JUMBO 8**  
Blocchiera da 8 cassette  
8 unit mailbox set

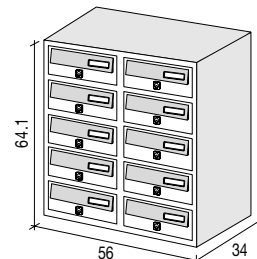

**JUMBO 10**  
Blocchiera da 10 cassette  
10 unit mailbox set



I modelli Jumbo 3, 4 e 5 sono accessoriabili con citofono, campanelli e telecamera della Serie Bricino Sfera e New Sfera. Jumbo 6, 8 e 10 sono accessoriabili solo con la Serie Bricino Sfera (vedi da pag. 42).

*Jumbo 3, 4 and 5 models can be provided with intercom, doorbells and video camera for Bricino Sfera and New Sfera Series. Jumbo 6, 8 and 10 models can be provided only Bricino Sfera Series (see page 42).*

Tutti i modelli Jumbo possono essere montati con la piantana standard Modular (vedi a pag. 38).

*All Jumbo models can be mounted with Modular support column (see page 38)*

# Serie JUMBO-ECONOMICO



(confezione da 1 pezzo)  
**INTERNO/ESTERNO PROTETTO**  
**FORMATO RIVISTA**

Corpo in lamiera elettrozincata verniciata alle polveri colore grigio antracite e sportello in profilato d'alluminio disponibile nei colori: anodizzato argento, anodizzato bronzo, verniciato rosso, verniciato bianco, verniciato verde, verniciato grigio antracite.

(1-piece package)  
**INDOORS/OUTDOORS-SHELTERED LOCATION**  
**MAGAZINE FORMAT**

Electrogalvanized sheet steel body, anthracite color epoxy powder painted, matt finish. Aluminium profile door. Colors available: anodized - silver, anodized - bronze painted - red, painted - white painted - green, painted - anthracite color.



J4VEAR  
Argento / Silver



J5VEBR  
Bronzo / Bronze



J6VERO  
Rosso / Red

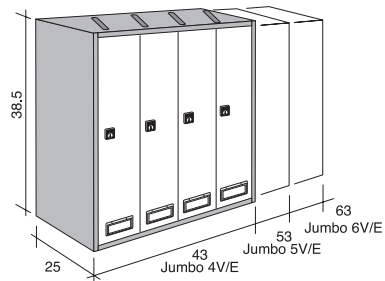

# Serie CUBO RIVISTA



C1RVGH



C1RVBR

(confezione da 10 pezzi)  
**INTERNO/ESTERNO PROTETTO**  
**FORMATO RIVISTA**

**Modello componibile**  
 Corpo forato sui lati per unire più cassette.

**VERTICALE**

- C1RVBR • In alluminio anodizzato bronzo
- C1RVGH • In alluminio verniciato grigio antracite

**ORIZZONTALE**

- C1ROBR • In alluminio anodizzato bronzo
- C1ROGH • In alluminio verniciato grigio antracite

(10-pieces package)  
**INDOORS/OUTDOORS-SHELTERED LOCATION**  
**MAGAZINE FORMAT**

**Modular model**

Predisposed for assembly of several mailboxes.

**VERTICAL**

- C1RVBR • Aluminium - bronze anodized
- C1RVGH • Aluminium - anthracite finish

**HORIZONTAL**

- C1ROBR • Aluminium - bronze anodized
- C1ROGH • Aluminium - anthracite finish

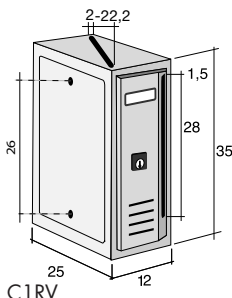

C1RV



Esempi di composizione a blocciera.  
 Examples of possible assembly



C1ROGH



C1ROBR

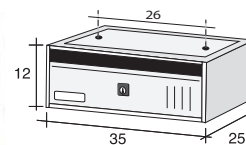

C1RO



Esempi di composizione a blocciera.  
 Examples of possible assembly

# Serie CUBO COMPOSTO



C4BR  
Bronzo/bronze

(confezione da 1 pezzi)  
**INTERNO/ESTERNO PROTETTO**

Corpo preforato sui lati per unione di più casellari.

- C4 • Blocchiera a 4 cassette in alluminio anodizzato bronzo, argento o verniciato grigio antracite cm 30 x 42 x 17,5
- C5 • Blocchiera a 5 cassette in alluminio anodizzato bronzo, argento o verniciato grigio antracite cm 30 x 52 x 17,5
- C6 • Blocchiera a 6 cassette in alluminio anodizzato bronzo, argento o verniciato grigio antracite cm 30 x 62 x 17,5

(1-piece package)  
**INDOORS/OUTDOORS-SHELTERED LOCATION**  
 Predisposed for assembly of several mailbox units.

- C4 • 4 unit mailbox set. Anodized aluminium bronze, silver or anthracite color paint finish 30 x 42 x 17.5 cm
- C5 • 5 unit mailbox set. Anodized aluminium bronze, silver or anthracite finish 30 x 52 x 17.5 cm
- C6 • 6 unit mailbox set. Anodized aluminium bronze, silver or anthracite finish 30 x 62 x 17.5 cm



C5GH  
Grigio antracite/Anthracite color



C6AR  
Argento/silver

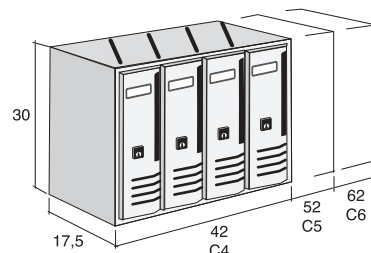

# Serie CUBO COMPOSTO RIVISTA



## VERTICALE - VERTICAL \*

- C4RV • Blocchiera a 4 cassette
- C5RV • Blocchiera a 5 cassette
- C6RV • Blocchiera a 6 cassette

- C4RV • 4 units mailbox set
- C5RV • 5 units mailbox set
- C6RV • 6 units mailbox set

(confezione da 1 pezzo)  
**INTERNO/ESTERNO PROTETTO**  
**FORMATO RIVISTA**

Corpo in lamiera elettrozincata verniciata alle polveri colore grigio antracite con sportello inox o verniciato bronzo antico, grigio antracite o oro.

(1-piece package)  
**INDOORS/OUTDOORS-SHELTERED LOCATION**  
**MAGAZINE FORMAT**

Electrogalvanized sheet steel body, anthracite color epoxy powder painted, matt finish. Antique bronze, anthracite color, gold painted door or S/S door.



C4RVGH:  
Grigio Antracite  
Anthracite color



C5RVBR:  
Bronzo Anticato  
Antique bronze



C6RVIX:  
Inox

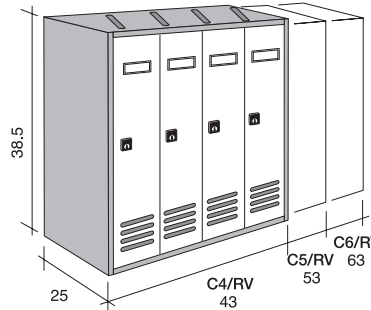

## ORIZZONTALE - HORIZONTAL \*

- C4RO • Blocchiera a 4 cassette
- C5RO • Blocchiera a 5 cassette
- C6RO • Blocchiera a 6 cassette

- C4RO • 4 units mailbox set
- C5RO • 5 units mailbox set
- C6RO • 6 units mailbox set



C4ROBR:  
Bronzo Anticato  
Antique bronze



C4ROOR:  
Oro / Gold



C5ROGH:  
Grigio antracite  
Anthracite color



C6ROIX:  
Inox

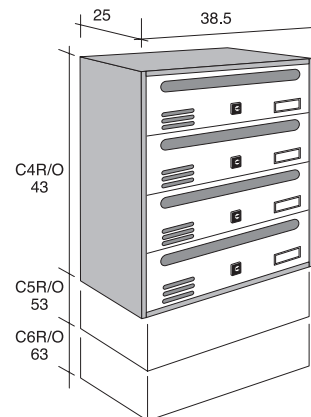

# NUOVO COLORE DISPONIBILE ARGENTO RAL 9006

(confezione da 1 pezzo)  
**INTERNO/ESTERNO PROTETTO - FORMATO RIVISTA**  
 Corpo e sportelli in lamiera elettrozincata verniciati alle polveri colore RAL 9006.

(1-piece package)  
**INDOORS/OUTDOORS-SHELTERED LOCATION - MAGAZINE FORMAT**  
 Electrogalvanized sheet steel body, silver RAL 9006 painted.

## VERTICALE - VERTICAL \*

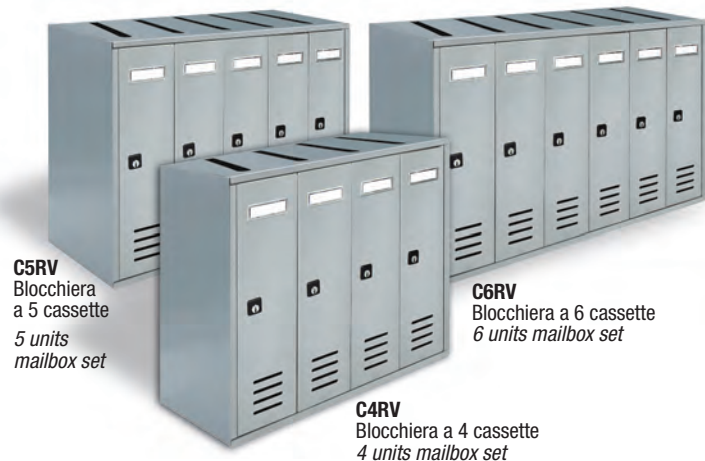

C5RV  
Blocchiera  
a 5 cassette  
5 units  
mailbox set

C6RV  
Blocchiera a 6 cassette  
6 units mailbox set

C4RV  
Blocchiera a 4 cassette  
4 units mailbox set

## ORIZZONTALE - HORIZONTAL \*



C5RO  
Blocchiera  
a 5 cassette  
5 units  
mailbox set

C6RO  
Blocchiera  
a 6 cassette  
6 units mailbox set

C4RO  
Blocchiera a 4 cassette  
4 units mailbox set

\* Corpo preforato sui lati per unione di più casellari. \* Predisposed for assembly of several mailbox units.

# Serie SE-SI



SEBR

(confezione da 10 pezzi)

### Modello componibile

Corpo forato sui lati per unire più cassette

#### PER ESTERNO PROTETTO

- SEBR • In alluminio anodizzato bronzo
- SEAR • In alluminio anodizzato argento
- SEGH • In alluminio verniciato grigio antracite
- SEAV • In alluminio verniciato avorio

#### PER INTERNO

Sprovista di elemento mobile e feritoie in plexiglas

- SIBR • In alluminio anodizzato bronzo
- SIAR • In alluminio anodizzato argento

(10-pieces package)

### Modular model

Predisposed for assembly of several mailboxes.

#### OUTDOORS - SHELTERED LOCATION

- SEBR • Aluminium - bronze anodized
- SEAR • Aluminium - silver anodized
- SEGH • Aluminium - anthracite finish
- SEAV • Aluminium - ivory paint finish

#### INDOORS

Not equipped with flap and plexiglas slots

- SIBR • Aluminium - bronze anodized
- SIAR • Aluminium - silver anodized

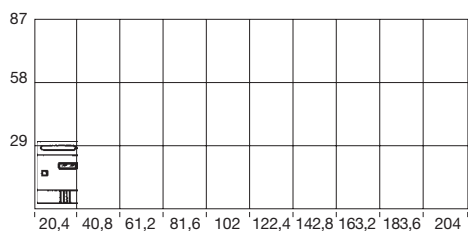

SEAR



SEGH



SEAV



SIBR



SIAR

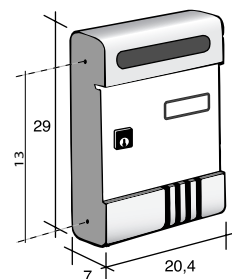

# Serie SIRE-SIR RIVISTA



SIREBR

(confezione da 6 pezzi)

### Modello componibile

Corpo forato sui lati per unire più cassette.

#### PER ESTERNO PROTETTO

- SIREBR • In alluminio anodizzato bronzo
- SIREAR • In alluminio anodizzato argento
- SIREGH • In alluminio verniciato grigio antracite
- SIREAV • In alluminio verniciato avorio

#### PER INTERNI - FORMATO RIVISTA

Sprovista di elemento mobile e feritoie in plexiglas

- SIRBR • In alluminio anodizzato bronzo

(6-pieces package)

### Modular model - MAGAZINE FORMAT

Predisposed for assembly of several mailboxes.

#### OUTDOORS - SHELTERED LOCATION

- SIREBR • Aluminium - bronze anodized
- SIREAR • Aluminium - silver anodized
- SIREGH • Aluminium - anthracite finish
- SIREAV • Aluminium - ivory paint finish

#### INDOORS - MAGAZINE FORMAT

Not equipped with flap and plexiglas slots

- SIRBR • Aluminium - bronze anodized

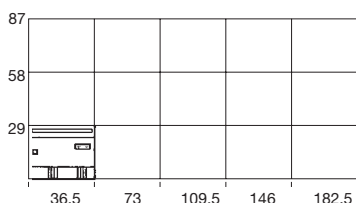

SIREAR



SIREGH



SIREAV



SIRBR

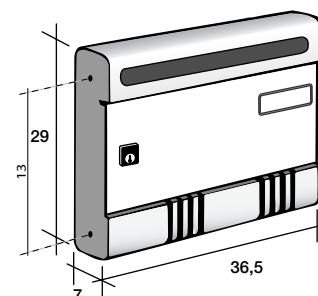

Casellari postali CONDOMINIALI  
**Serie CURVE e MODULAR**  
Mailbox units for custom configuration  
**CURVE and MODULAR Series**

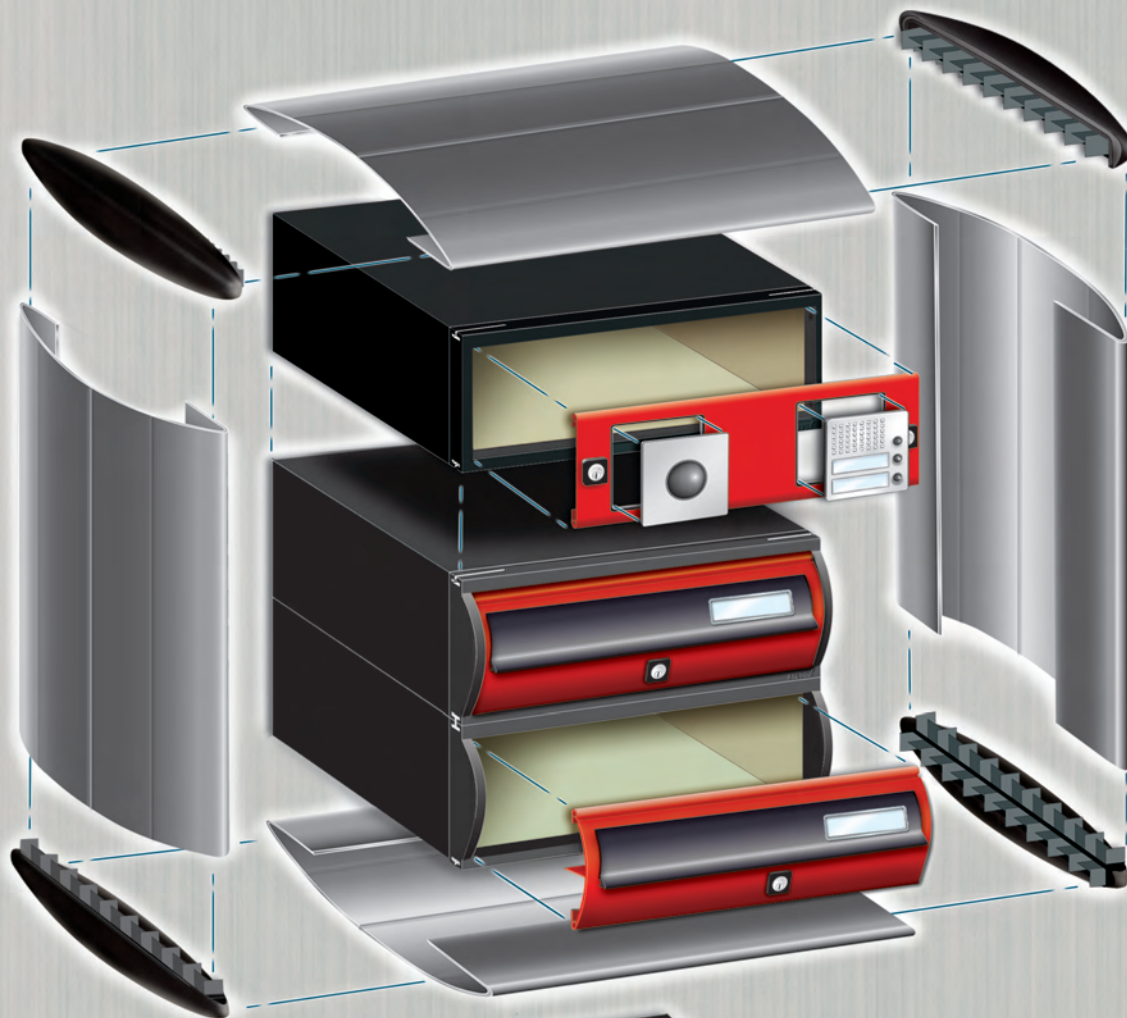

*Modular*<sup>®</sup>



by  
**ALUBOX**  
MADE IN ITALY

MODELLO CONFORME  
NORMA EUROPEA  
EN 13724



# Casellari Postali MODULAR E CURVE

MADE IN ITALY

Le Casette Postali della Serie MODULAR e della Serie CURVE sono conformi alle normative EN 13724

**MODELLO CONFORME**  
**NORME EUROPEE**  
**EN 13724**

Le norme EN 13724 sono una realtà in tutti gli Stati dell'Unione Europea.

In sintesi, le norme EN impongono il rispetto di determinate regole nella produzione delle cassette postali, quali: **dimensioni, materiali, robustezza e sicurezza.**

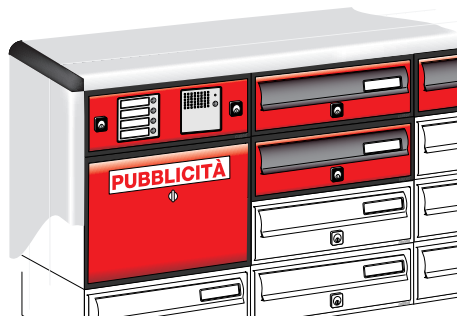
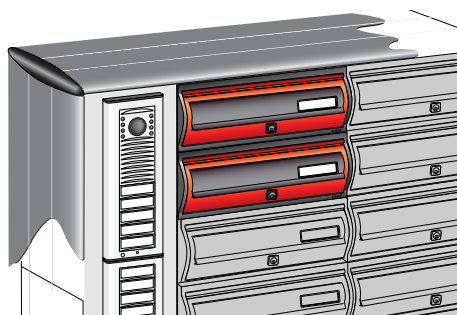
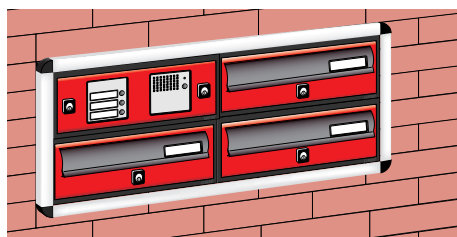
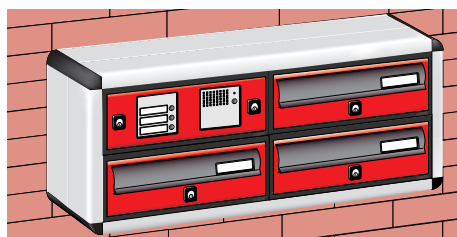
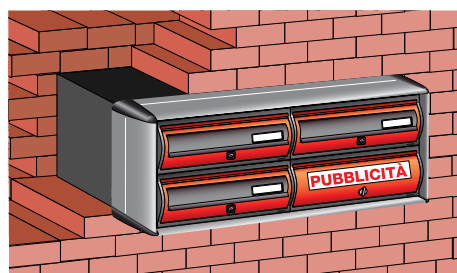
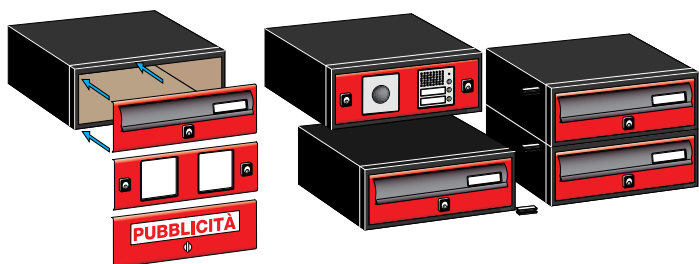

Nella vasta gamma di prodotti che Alubox offre la Serie MODULAR e la Serie CURVE sono le linee di punta.

Alubox si propone, attraverso il Progetto MODULAR, di soddisfare un sempre maggior numero di richieste, realizzando cassette postali modulari componibili.

Le caratteristiche fondamentali di tutta la serie MODULAR e la serie CURVE sono senza dubbio la versatilità, la resistenza nel tempo, l'estetica e la funzionalità.

**Nella progettazione della Serie MODULAR e Serie CURVE si è tenuto rigorosamente conto delle nuove Normative Europee EN 13724.**

Tali normative prevedono la regolamentazione della produzione delle cassette postali in fatto di dimensioni, in quanto devono essere in grado di contenere riviste, avere caratteristiche anti effrazione ed essere realizzate in modo tale da salvaguardare la privacy e la sicurezza delle persone.

## VERSATILITÀ

I nostri casellari sono adatti a qualsiasi tipo di installazione: da incasso totale oppure parziale a muro, fissaggio a parete, recinzione, su piantana per l'esterno, complete di mantello o cornice coprifuga a seconda del tipo di ubicazione.

Utilizzando appositi sportelli o placche porta accessori si possono predisporre tutti i casellari di campanelli, citofoni, telecamere e numeri civici delle migliori e più diffuse marche presenti sul mercato (gli accessori non sono direttamente forniti).

## RESISTENZA

I materiali utilizzati per la realizzazione della MODULAR e della CURVE sono stati studiati per resistere agli agenti atmosferici e per garantire una lunga durata nel tempo: il corpo delle cassette è in alluminio preverniciato, mentre il mantello di rivestimento, la cornice coprifuga e gli sportelli sono realizzati in profilato di alluminio anodizzato o verniciato alle polveri.

## ESTETICA

È possibile scegliere tra molteplici finiture sia per gli sportelli che per il mantello di rivestimento, tra i colori anodizzati o verniciati, richiedendo preventivi personalizzati.

## FUNZIONALITÀ

Tutte le cassette sono dotate di pratico elemento mobile basculante per l'introduzione di posta formato rivista, sono altresì fornite di sportello con serratura per prelevare la posta in modo comodo e veloce.

Modular®



by ALUBOX

## 1) DIMENSIONI

Le misure minime fanno riferimento al formato EN C4 di 229 x 324 mm.

Alcune misure definite dalle norme EN:

- dimensioni minime della feritoia: 325 x 30 mm
- profondità minima delle cassette verticali: 100 mm
- altezza minima del vano protetto dall'elemento antiprelievo: 40 mm
- dimensioni minime della targhetta portanome: 60x15 mm

## 2) ANTIPRELIEVO

La cassetta deve essere dotata di un dispositivo antiprelievo che, una volta introdotta la corrispondenza, ne ostacoli efficacemente l'estrazione dal vano di introduzione, evitando prelievi da parte di persone non autorizzate. Lamina antiprelievo: 15 mm di profondità e nella lunghezza minima dell'80% della feritoia.

## 3) ROBUSTEZZA

La cassetta deve essere resistente agli agenti atmosferici e deve essere prodotta con lamiera di spessore non inferiore a 1,2 mm. La capacità di resistenza dello sportello deve essere di almeno 15 daN.

Anche in Italia, l'Ente Poste, con le normative pubblicate il 06/04/2001 sulla Gazzetta Ufficiale, mira a regolamentare la produzione e l'installazione delle cassette postali.

## CASSETTE DOMICILIARI

Art. 45

### Cassette:

Per la distribuzione degli invii semplici devono essere installate, a spese di chi le posa, cassette accessibili al portalettore. Lo scomparto di deposito, la forma e le dimensioni dell'apertura devono rispondere alle esigenze del traffico postale e risultare tali da consentire di introdurre gli invii senza difficoltà particolari. Le cassette devono recare, ben visibile, l'indicazione del nome dell'interessatario e di chi ne fa uso.

Art. 46

### Ubicazione:

Le cassette devono essere collocate al limite della proprietà, sulla pubblica via o comunque in luogo liberamente accessibile, salvi accordi particolari con l'ufficio postale di distribuzione.

Art. 47

### Edifici plurifamiliari o adibiti ad uso d'impresa:

Negli edifici plurifamiliari, nei complessi formati da più edifici e negli edifici adibiti a sede d'impresa, le cassette delle lettere devono essere raggruppate in un unico punto di accesso.

Art. 48

### Adeguamento delle cassette non conformi

I titolari di cassette non conformi alle specifiche richieste da Poste Italiane provvedono ai necessari adattamenti entro un termine concordato con l'ufficio richiedente.

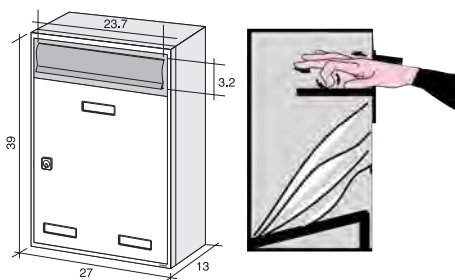
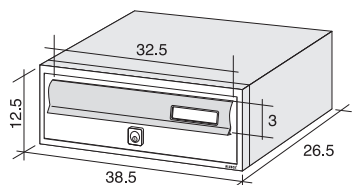
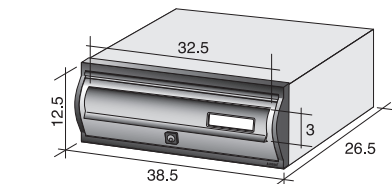

**ALUBOX**  
Cassette Postali - Mailboxes MADE IN ITALY

# Serie CURVE 1

esempi di installazioni possibili

# CURVE 1 Series

examples of possible installations

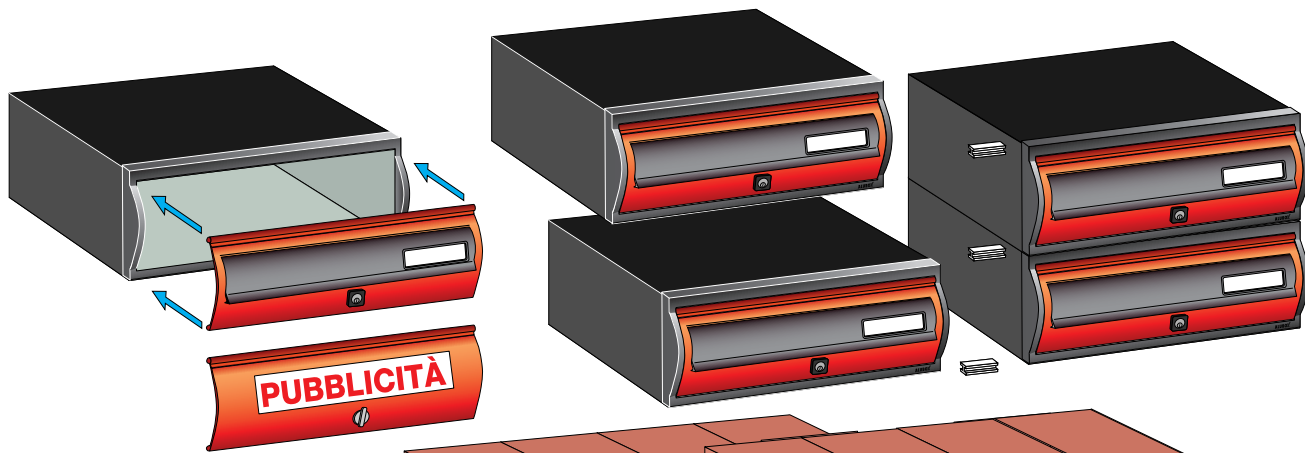

Composizione semincasso con mantello  
Configuration with outer casing for semi-recessed mounting

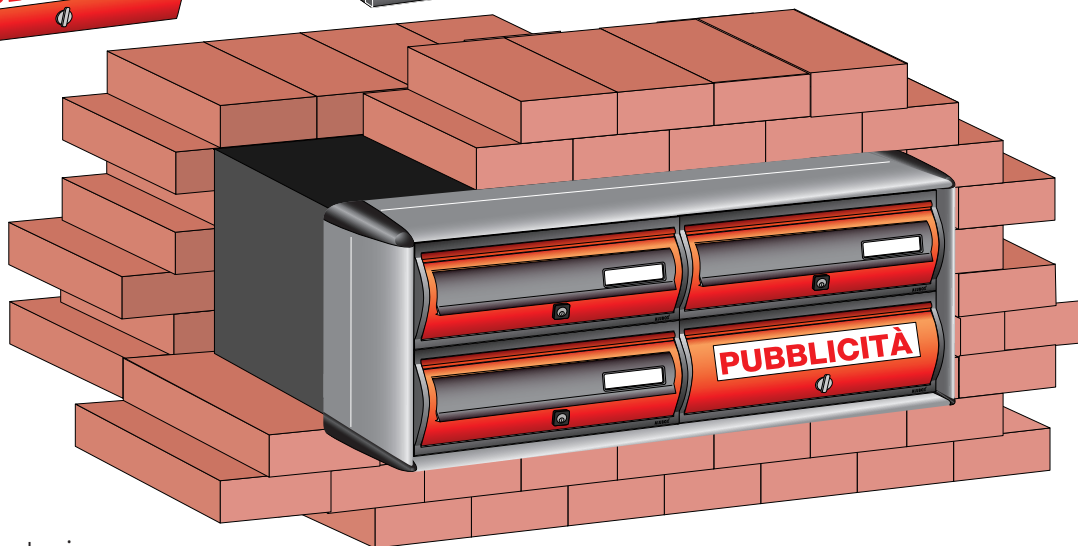

Composizione con mantello per esterni  
Configuration with outer casing for outdoors

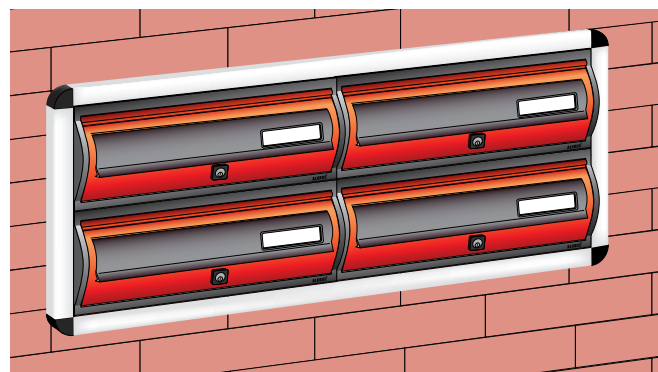
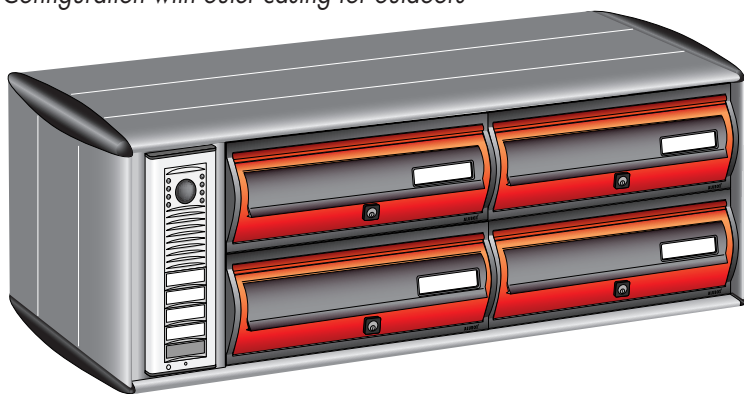

Composizione da incasso con cornice coprifuga  
Configuration for recessed mounting with external frame

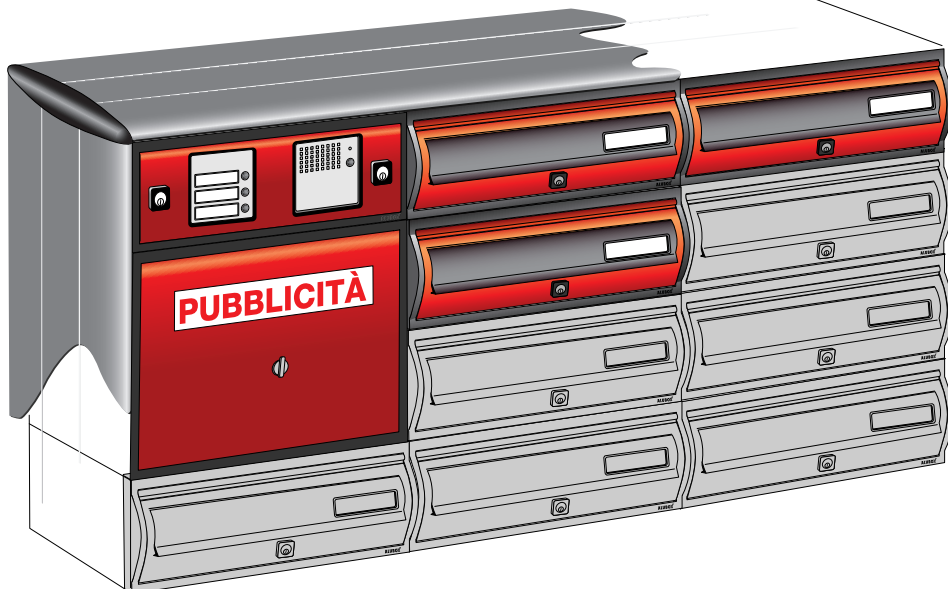

Composizione con mantello, sportello SP1 ACC predisposto per l'inserimento di pannelli, telecamera, citofono e numero civico per i modelli BTicino Sfera e corpo doppio pubblicità.  
Accessori vedi da pag. 42.

Example of configuration with outer casing, composed to SP1 ACC door suitable for door bells videocamera intercom, residence number for BTicino Sfera brand and double box for advertising.  
Accessories, see page 42.

Serie **CURVE 1** - PRELIEVO FRONTALE - FRONT ACCESSEsterno  
con  
mantello

Interno

formato  
TRIVISTA

Tricasso

COMPONIBILE

MODELLO CONFORME  
EN 13724

Esempio cassetta Curve 1: Corpo (C1) + Sportello (SP1)  
Example of Curve 1 mailbox: Body (C1) + Door (SP1)



CURVE C1 CGH  
con cornice di plastica grigio antracite - with anthracite color plastic frame

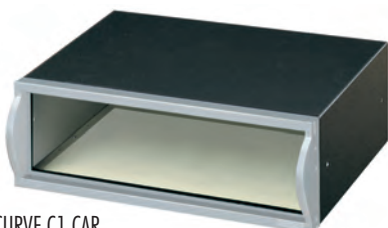

CURVE C1 CAR  
con cornice di plastica argento - with silver plastic frame

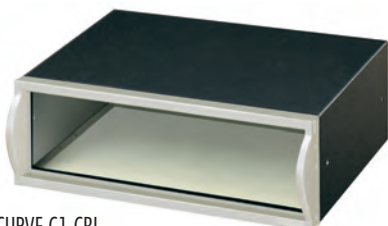

CURVE C1 CBI  
con cornice di plastica bianca - with white plastic frame

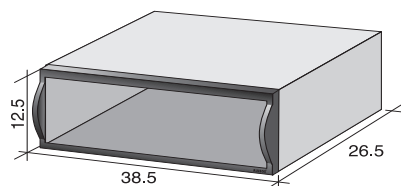

CURVE C1

(confezione da 6 pezzi)  
**CORPO SERIE CURVE 1**  
**PRELIEVO FRONTALE**

**C1** • Corpo per cassetta componibile  
in alluminio

**C1F** • Corpo per cassetta componibile  
in lamiera elettrozincata

(6-pieces package)  
**CURVE SERIES 1 BODY**  
**FRONT ACCESS**

**C1** • Body for modular mailbox - aluminium

**C1F** • Body for modular mailbox  
electrogalvanized sheet steel

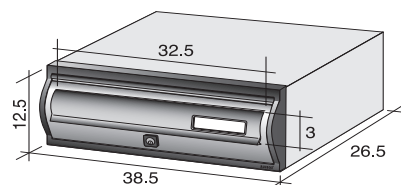

CURVE 1 completa - CURVE 1 complete box

**Colori RAL a richiesta senza supplemento di prezzo** (previa disponibilità presso verniciatura).

(confezione 6 pezzi)

**SPORTELLO Curve SP1**

**Sportello per corpo Curve 1 completo di elemento mobile in profilato d'alluminio:**

- anodizzato argento
- verniciato grigio antracite RAL 7016
- verniciato rosso RAL 3003 con elemento mobile grigio antracite RAL 7016
- verniciato verde RAL 6005 con elemento mobile grigio antracite RAL 7016
- verniciato bianco RAL 9016
- verniciato grigio antracite RAL 7016 con elemento mobile metallizzato argento
- verniciato ruggine
- verniciato metallizzato argento
- verniciato metallizzato argento con elemento mobile grigio antracite RAL 7016
- con Kit Pubblicità

**Tutta la Serie Curve viene fornita con corpo e sportelli smontati.**

Nelle composizioni della Serie CURVE 1 è possibile inserire un corpo doppio con sportello pubblicità.

**RAL colors on request without additional charge** (subject to availability at varnisher).

(6-pieces package)

**Curve SP1 DOOR**

**Aluminium profile door for Curve 1 body, complete with flap:**

- anodized - silver
- painted in anthracite color RAL 7016
- painted in RAL 3003 red, with anthracite color RAL 7016 flap
- painted in RAL 6005 green, with anthracite color RAL 7016 flap
- painted in RAL 9016 white
- painted in anthracite color RAL 7016, with metallic silver flap
- painted in rust
- painted in metallic silver
- painted in metallic silver, with anthracite color RAL 7016 flap
- with publicity kit

**CURVE series mailboxes are supplied in loose form ready for assembly.**

It's possible to supply double height box for publicity for CURVE 1 Series.



CURVESPIAR



CURVESPIRUG



CURVESPIGH - Ral 7016



CURVESPIARMET



CURVESPIRO / el. mob. GH - Ral 7016



CURVESPIARMET / el. mob. GH - Ral 7016



CURVESPIVE / el. mob. GH - Ral 7016



CURVESPI PUB  
con kit pubblicità (vedi pag. 88) - with publicity kit (see page 88)



CURVESPIBI



CURVESPIGH / el. mob. ARMET



(confezione da 1 pezzo)

**CORPO DOPIO** con sportello pubblicità.

(1-piece package)

**DOUBLE HEIGHT BOX** with publicity door.

## Serie CURVE 2

esempi di installazioni possibili

## CURVE 2 Series

examples of possible installations

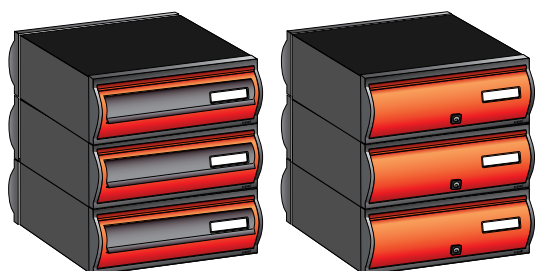
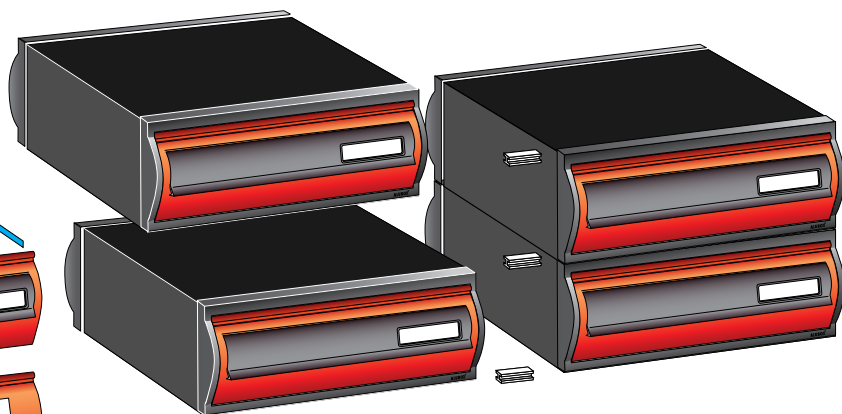
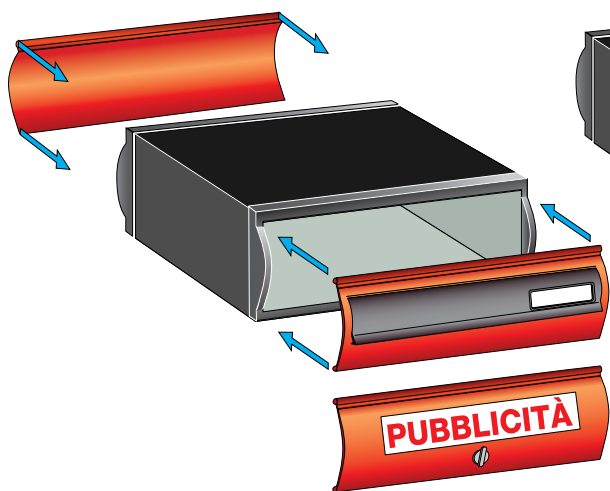

CURVESP2F  
Fronte / Front view

CURVESP2R  
Retro / Rear view

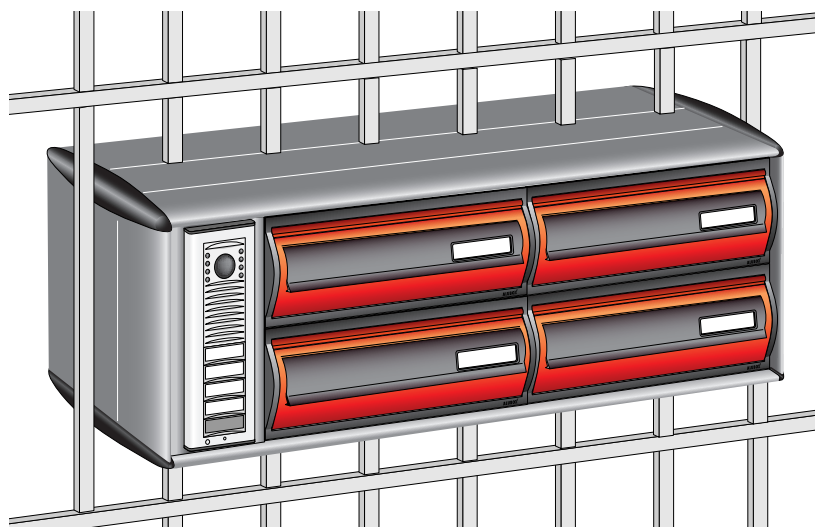
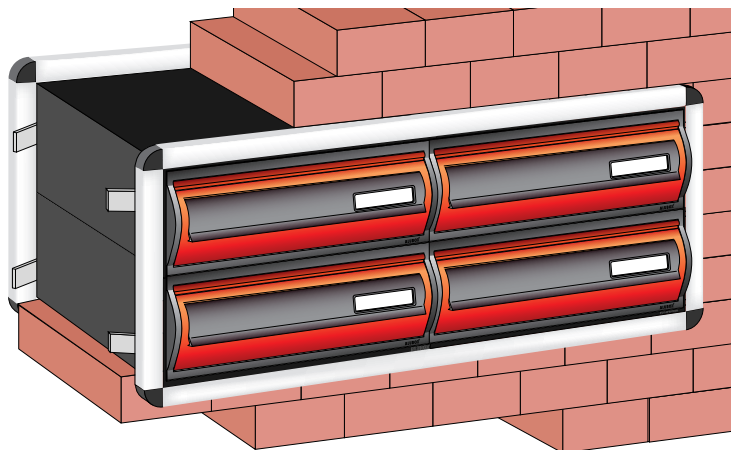

Composizione da incasso  
con doppia cornice  
*Configuration for recessed mounting  
with double external frame*

Composizione con mantello  
da recinzione  
*Configuration with outer casing  
for fence mounting*

Composizione con mantello, sportello SP1 ACC predisposto per l'inserimento di campanelli, telecamera, citofono e numero civico per i modelli BTicino Sfera e corpo doppio pubblicità. Accessori vedi da pag. 42

*Example of configuration with outer casing, composed to SP1 ACC door suitable for door bells videocamera intercom, residence number for BTicino Sfera brand and double box for advertising. Accessories, see page 42.*

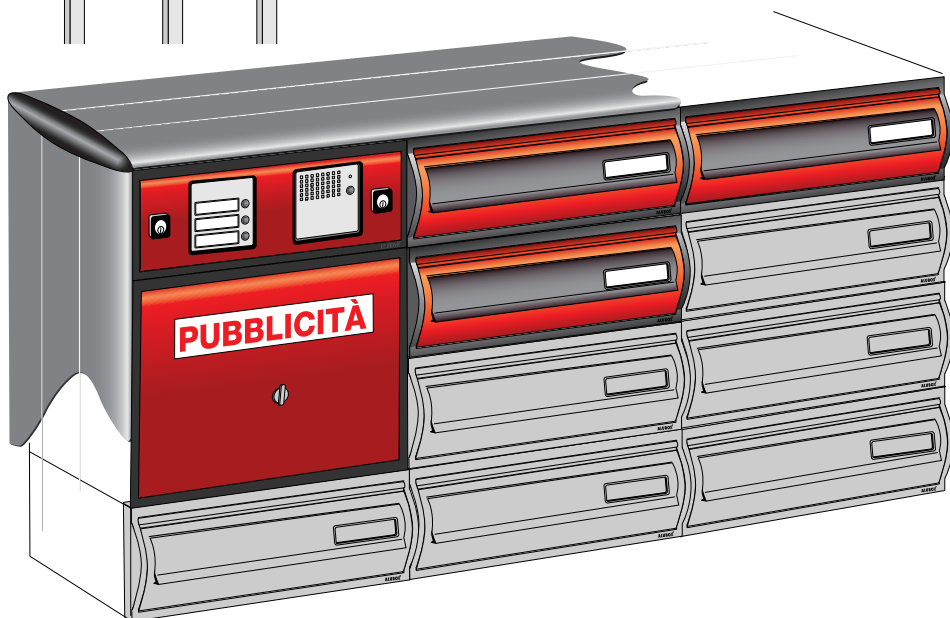

Serie **CURVE 2** - PRELIEVO POSTERIORE - REAR ACCESSEsterno  
con  
mantello

Interno

formato  
RIVISTA

Licasso

COMPONIBILE

MODELLO CONFORME  
EN 13724

Esempio cassetta Curve 2: Corpo (C2) + Sportello (SP2F)  
Example of Curve 2 mailbox: Body (C2) + Door (SP2F)

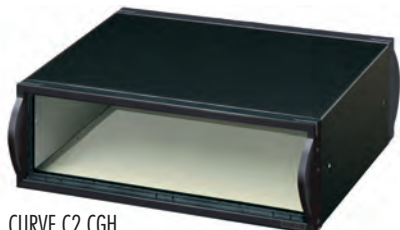

CURVE C2 CGH  
con cornice di plastica grigio antracite - with anthracite color plastic frame

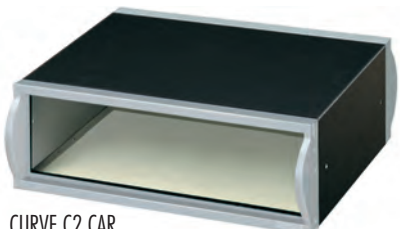

CURVE C2 CAR  
con cornice di plastica argento - with silver plastic frame

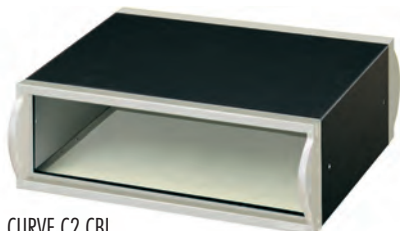

CURVE C2 CBI  
con cornice di plastica bianca - with white plastic frame

(confezione da 6 pezzi)

**CORPO SERIE CURVE 2  
PRELIEVO POSTERIORE****C2** • Corpo per cassetta componibile  
in **alluminio****C2F** • Corpo per cassetta componibile  
in **lamiera elettrozincata**

(6-pieces package)

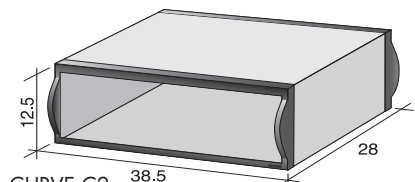
**CURVE SERIES 2 BODY  
REAR ACCESS****C2** • Body for modular mailbox - **aluminium****C2F** • Body for modular mailbox  
**electrogalvanized sheet steel**

CURVE C2

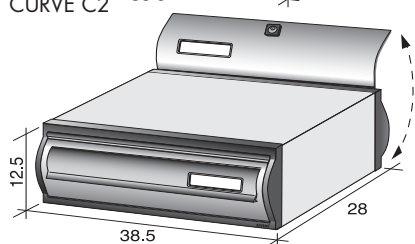

CURVE 2 completa - CURVE 2 complete box

Colori RAL a richiesta senza supplemento di  
prezzo (previa disponibilità presso verniciatura).

(confezione 6 pezzi)

**SPORTELLO Curve SP2F**Sportello frontale per serie Curve 2 completo  
di elemento mobile in profilato d'alluminio:

- anodizzato argento
- verniciato grigio antracite RAL 7016
- verniciato rosso RAL 3003  
con elemento mobile grigio antracite RAL 7016
- verniciato verde RAL 6005  
con elemento mobile grigio antracite RAL 7016
- verniciato bianco RAL 9016
- verniciato grigio antracite RAL 7016  
con elemento mobile metallizzato argento
- verniciato ruggine
- verniciato metallizzato argento
- verniciato metallizzato argento  
con elemento mobile grigio antracite RAL 7016
- con Kit Pubblicità

**SPORTELLO Curve SP2R**

- Sportello Curve SP2R retro per Curve 2,  
finiture come per SP2F, completo di serratura

**Tutta la Serie Curve viene fornita  
con corpo e sportelli smontati.**

Nelle composizioni della Serie CURVE 2 è possibile  
inserire un corpo doppio con sportello pubblicità.



CURVESP2FAR



CURVESP2FGH - Ral 7016

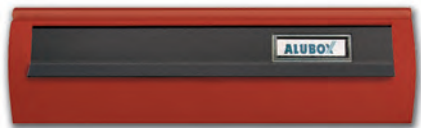

CURVESP2FRO / el. mob. GH - Ral 7016



CURVESP2FVE / el. mob. GH - Ral 7016



CURVESP2FBI



CURVESP2FGH / el. mob. ARMET

RAL colors on request without additional  
charge (subject to availability at varnisher).

(6-pieces package)

**Curve SP2F DOOR**Aluminium profile front door for Curve 2  
series complete with flap:

- anodized - silver
- painted in anthracite color RAL 7016
- painted in RAL 3003 red,  
with anthracite color RAL 7016 flap
- painted in RAL 6005 green,  
with anthracite color RAL 7016 flap
- painted in RAL 9016 white
- painted in anthracite color RAL 7016,  
with metallic silver flap
- painted in rust
- painted in metallic silver
- painted in metallic silver,  
with anthracite color RAL 7016 flap
- with publicity kit

**Curve SP2R DOOR**

- Rear door Curve SP2R for Curve 2.  
Same finishes as SP2F, complete with lock

**CURVE series mailboxes are  
supplied in loose form ready for assembly.**

It's possible to supply double height box  
for publicity for CURVE 2 Series.

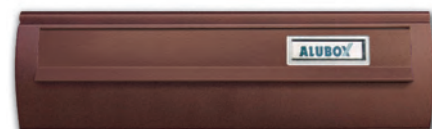

CURVESP2FRUG



CURVESP2FARMET



CURVESP2FARMET / el. mob. GH - Ral 7016



CURVESP1PUB  
con kit pubblicità (vedi pag. 88) - with publicity kit (see page 88)



(confezione da 1 pezzo)  
**CORPO DOPPIO** con sportello pubblicità con  
2 sportelli, fronte e retro.

(1-piece package)

**DOUBLE HEIGHT BOX** with publicity door,  
rear and front door.

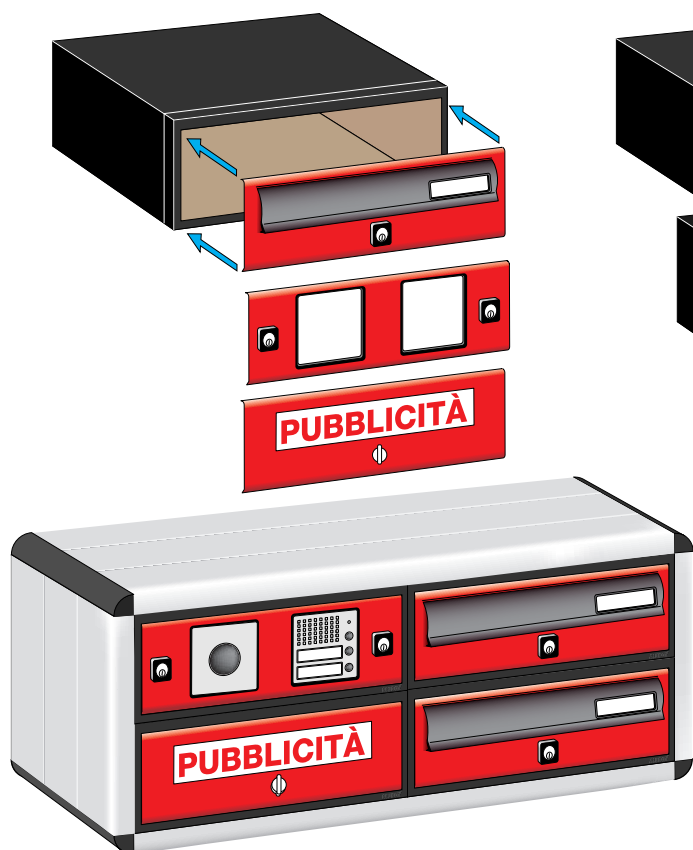

Composizione con mantello per esterni  
 Configuration with outer casing for outdoors

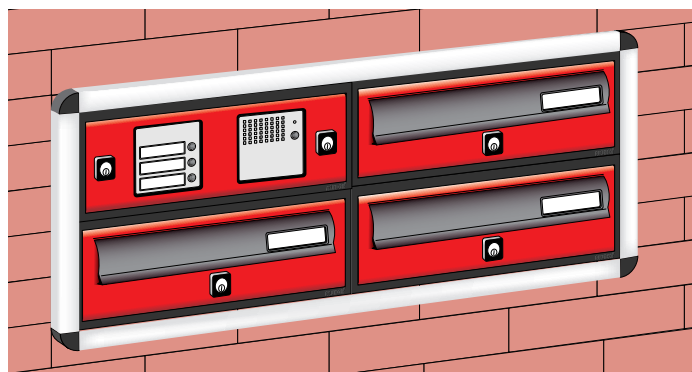

Composizione da incasso con cornice coprifuga  
 Configuration for recessed mounting with external frame

Composizione semincasso con mantello  
 Configuration with outer casing for semi-recessed mounting

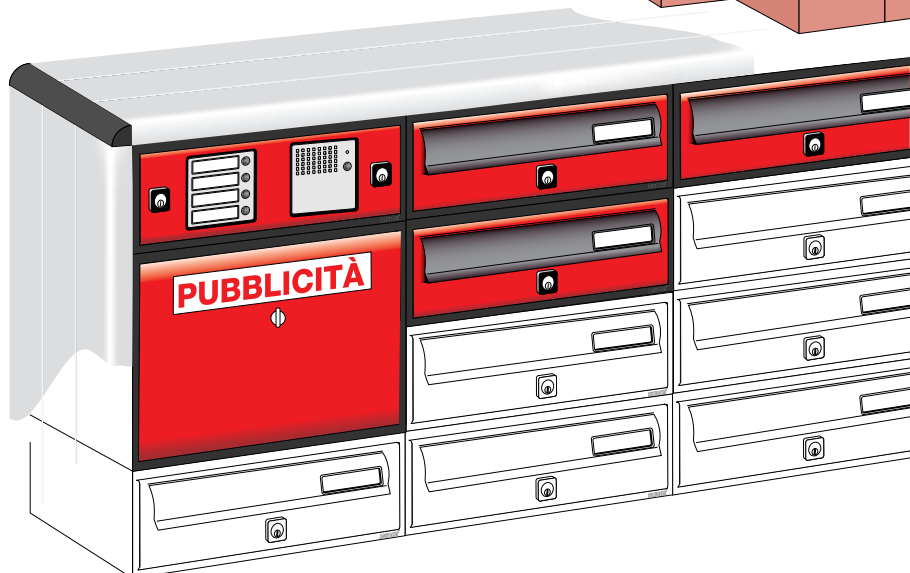
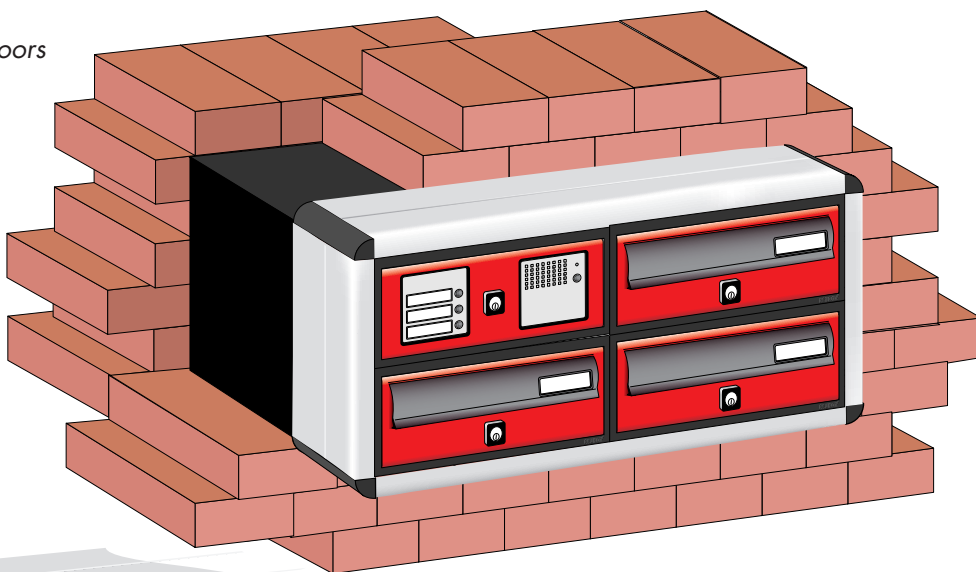

Composizione con mantello, sportello SP1 ACC predisposto per l'inserimento di campanelli, telecamera, citofono e numero civico per i modelli BTicino Sfera e corpo doppio pubblicità. Accessori vedi da pag. 42.

Example of configuration with outer casing, composed to SP1 ACC door suitable for door bells videocamera intercom, residence number for BTicino Sfera brand and double box for advertising. Accessories, see page 42.



Esempio cassetta Modular 1: Corpo (C1) + Sportello (SP1)  
Example of Modular 1 mailbox: Body (C1) + Door (SP1)



Modular C1 CGH  
con cornice di plastica grigio antracite - with anthracite color plastic frame

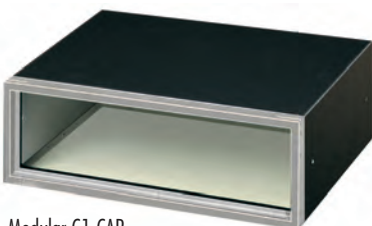

Modular C1 CAR  
con cornice di plastica argento - with silver plastic frame



Modular C1 CBI  
con cornice di plastica bianca - with white plastic frame

(confezione da 6 pezzi)

### CORPO MODULAR 1 PRELIEVO FRONTALE

**C1** • Corpo per cassetta componibile  
in **alluminio**

**C1F** • Corpo per cassetta componibile  
in **lamiera elettrozincata**

(6-pieces package)

### MODULAR 1 BODY FRONT ACCESS

**C1** • Body for modular mailbox - **aluminium**

**C1F** • Body for modular mailbox  
**electrogalvanized sheet steel**

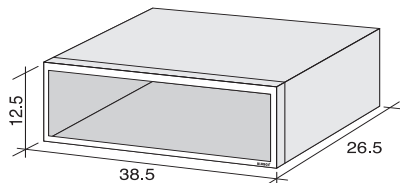

MODULAR C1

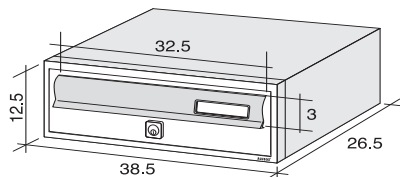

MODULAR 1 completa - MODULAR 1 complete box

## PRELIEVO FRONTALE

(confezione 6 pezzi)

### SPORTELLO Modular SP1

Sportello per Modular 1, completo di elemento mobile, in profilato d'alluminio:

- anodizzato argento
- anodizzato bronzo
- verniciato rosso RAL 3003 con elemento mobile grigio antracite RAL 7016
- verniciato verde RAL 6005 con elemento mobile grigio antracite RAL 7016
- verniciato bianco RAL 9016
- verniciato grigio antracite RAL 7016
- verniciato grigio antracite RAL 7016 con elemento mobile in ottone
- con Kit Pubblicità

Tutta la Serie MODULAR viene fornita con corpo e sportelli smontati.



SP1AR

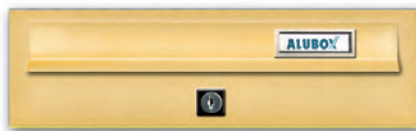

SP1BR



SP1R0 / el. mob. GH - Ral 7016



SP1VE / el. mob. GH - Ral 7016



SP1BI

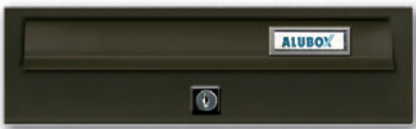

SP1GH - Ral 7016

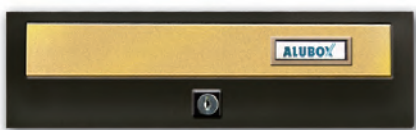

SP1OTT con elemento mobile in ottone  
SP1OTT with polished brass flap



SP1PUB con kit pubblicità (vedi pag. 88)  
SP1PUB with publicity kit (see page 88)

## FRONT ACCESS

(6-pieces package)

### DOOR MODULAR SP1

Aluminium profile universal door for Modular 1 body, complete with flap:

- anodized - silver
- anodized - bronze
- painted in RAL 3003 red, with anthracite color RAL 7016 flap
- painted in RAL 6005 green, with anthracite color RAL 7016 flap
- painted in RAL 9016 white
- painted in cast-iron
- painted in anthracite color RAL 7016 with brass flap
- with publicity kit

MODULAR series mailboxes are supplied in loose form ready for assembly.

MODULAR 200/1

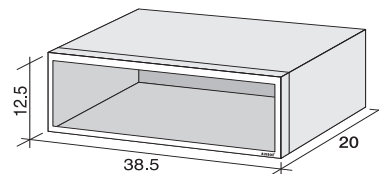

**C2001** • Corpo per cassetta componibile in alluminio con profondità 20 cm.

**SOLO DA INCASSO CON CORNICE**

**NON CONFORME ALLE NORMATIVE EN 13724**

**C2001** • Body for modular mailbox aluminium with 20 cms depth.

**ONLY FOR RECESS MOUNTING WITH EXTERNAL FRAME. NOT IN ACCORDANCE WITH EUROPEAN STANDARD RULES EN 13724**

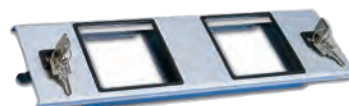

### SPORTELLO SP1 ACC

Sportello Serie MODULAR in profilato d'alluminio predisposto per l'inserimento di campanelli, telecamera, citofono e numero civico per i modelli BTicino Sfera. Accessori vedi da pag. 42. Finiture: vedi SP1

### SP1 ACC DOOR

MODULAR series panel in aluminium profile designed for incorporating doorbells, video camera, intercom and residence number for models BTicino Sfera. Accessories, see from page 42. Types of finish: see SP1



AM1 - Kit antivandalo con chiusura a tre punti per modello SP1.  
AM1 - Anti-vandal kit with three-point lock for SP1 door.



(confezione da 1 pezzo)  
**CORPO DOPPIO**  
con sportello pubblicità.

(1-piece package)  
**DOUBLE HEIGHT BOX**  
with publicity door.



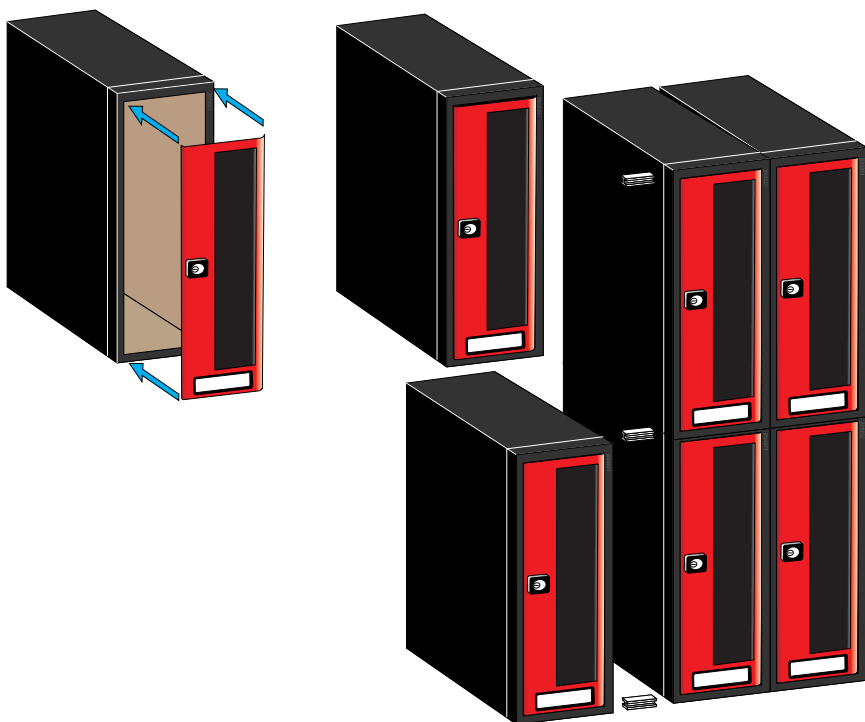

Composizione con mantello  
Configuration with outer casing

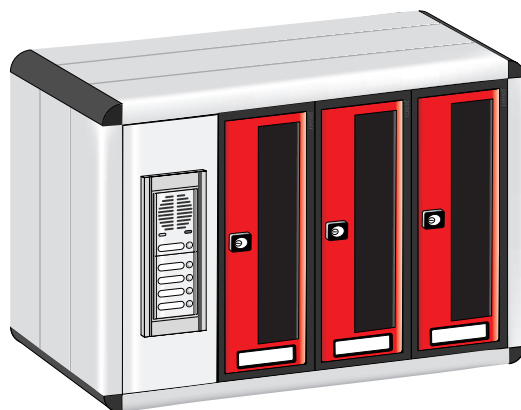

Composizione incasso  
con cornice coprifuga  
Configuration for recessed mounting  
with external frame

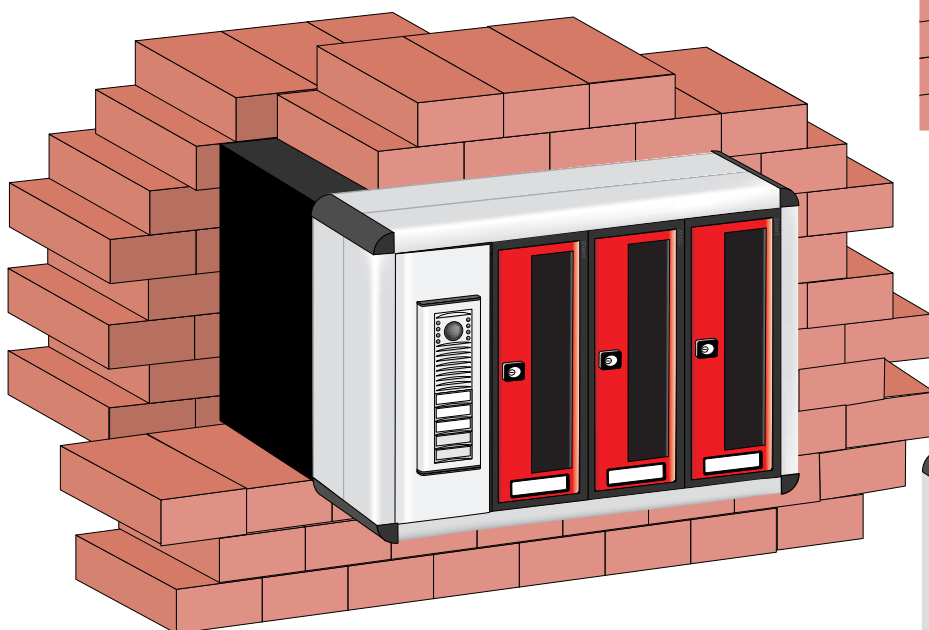

Composizione semincasso con mantello  
Configuration with outer casing  
for semi-recessed mounting



# Serie MODULAR 1 - 200/1 VERTICALE

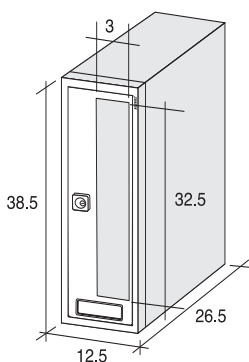

Esempio cassetta Modular 1V:  
Corpo (C1) + Sportello (SP1V)  
Example of Modular 1V mailbox:  
Body (C1) + Door (SP1V)

Modular 1V completa  
Modular 1V complete box

## PRELIEVO FRONTALE

(confezione 6 pezzi)

### SPORTELLI Modular SP1V

Sportello per Modular 1 verticale completo di elemento mobile, in profilato d'alluminio:

- anodizzato argento
- anodizzato bronzo
- verniciato rosso RAL 3003 con elemento mobile grigio antracite RAL 7016
- verniciato verde RAL 6005 con elemento mobile grigio antracite RAL 7016
- verniciato bianco RAL 9016
- verniciato grigio antracite RAL 7016

Tutta la Serie MODULAR viene fornita con corpo e sportelli smontati.

## FRONT ACCESS

(6-pieces package)

### MODULAR SP1V DOOR

Aluminium profile door for vertical Modular 1, complete with flap:

- anodized - silver
- anodized - bronze
- painted in RAL 3003 red, with anthracite color RAL 7016 flap
- painted in RAL 6005 green, with anthracite color RAL 7016 flap
- painted in RAL 9016 white
- painted in anthracite color RAL 7016

MODULAR series mailboxes are supplied in loose form ready for assembly.



Modular C1 CGH  
con cornice di plastica grigio antracite  
with anthracite color plastic frame



Modular C1 CAR  
con cornice di plastica argento  
with silver plastic frame



SP1VAR



SP1VBR



SP1VRO el. mob.  
GH - Ral 7016

### MODULAR 200/1

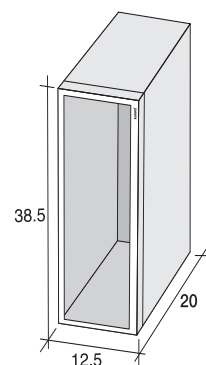

C2001 • Corpo per cassetta componibile in alluminio con profondità 20 cm.

SOLO DA INCASSO CON CORNICE

NON CONFORME ALLE NORMATIVE EN 13724

C2001 • Body for modular mailbox aluminium with 20 cms depth.

ONLY FOR RECESS MOUNTING WITH EXTERNAL FRAME.  
NOT IN ACCORDANCE WITH EUROPEAN STANDARD RULES EN 13724



Modular C1 CBI  
con cornice di plastica bianca  
with white plastic frame

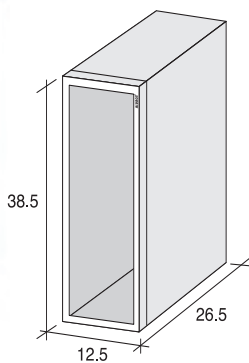

SP1VVE el. mob.  
GH - Ral 7016



SP1VBI



SP1VGH - Ral 7016

(confezione da 6 pezzi)

## CORPO MODULAR 1 PRELIEVO FRONTALE

C1 • Corpo per cassetta componibile in alluminio

C1F • Corpo per cassetta componibile in lamiera elettrozincata

(6-pieces package)

### MODULAR 1 BODY

#### FRONT ACCESS

C1 • Body for modular mailbox - aluminium

C1F • Body for modular mailbox electrogalvanized sheet steel



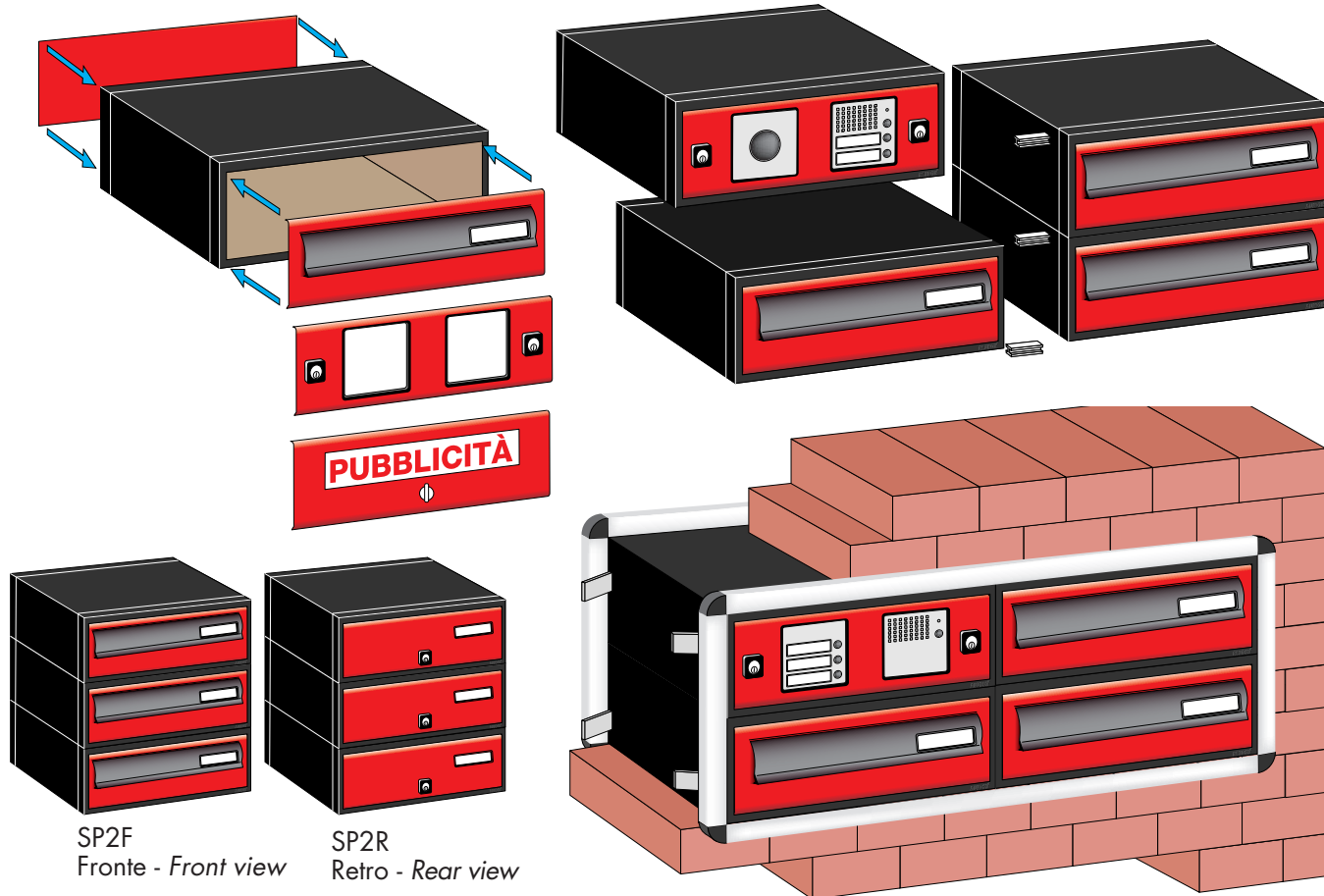

SP2F  
Fronte - Front view

SP2R  
Retro - Rear view

Composizione da incasso con doppia cornice  
Configuration for recessed mounting with double external frame

Composizione con mantello da recinzione  
Configuration with outer casing for fence mounting

Composizione con mantello, sportello SP1 ACC predisposto per l'inserimento di campanelli, telecamera, citofono e numero civico per i modelli BTicino Sfera e corpo doppio pubblicità. Accessori vedi da pag. 42.

Example of configuration with outer casing, composed to SP1 ACC door suitable for door bells videocamera intercom, residence number for BTicino Sfera brand and double box for advertising. Accessories, see page 42.

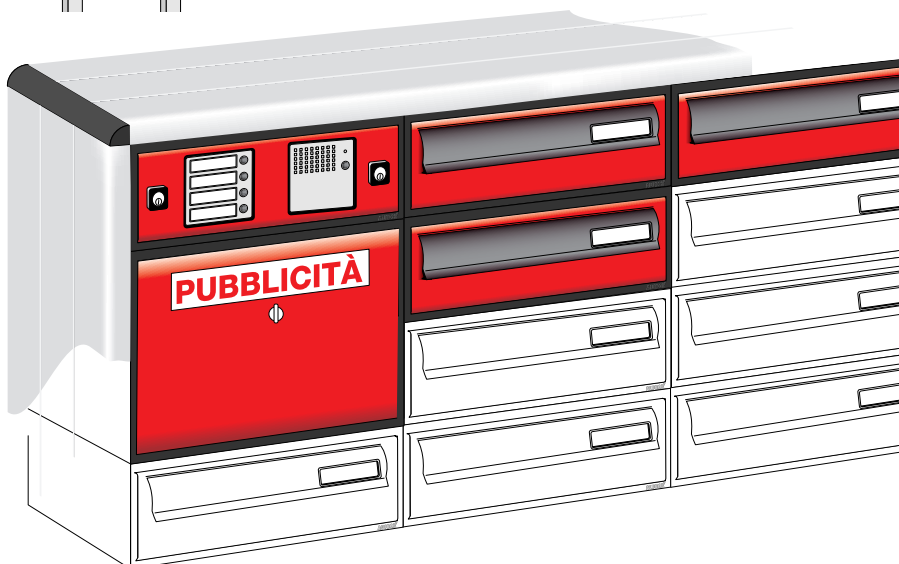



Esempio cassetta Modular 2: Corpo (C2) + Sportello (SP2F)  
Example of Modular 2 mailbox: Body (C2) + Door (SP2F)



Modular C2 CGH  
con cornice di plastica grigio antracite - with anthracite color plastic frame

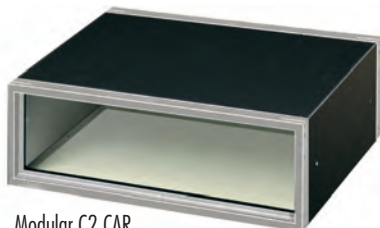

Modular C2 CAR  
con cornice di plastica argento - with silver plastic frame



Modular C2 CBI  
con cornice di plastica bianca - with white plastic frame

(confezione da 6 pezzi)

### CORPO MODULAR C2 PRELIEVO POSTERIORE

- C2** • Corpo per cassetta componibile in alluminio  
**C2F** • Corpo per cassetta componibile in lamiera elettrozincata

(6-pieces package)

### MODULAR C2 BODY REAR ACCESS

- C2** • Body for modular mailbox - aluminium  
**C2F** • Body for modular mailbox electrogalvanized sheet steel

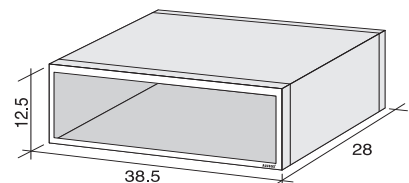

MODULAR C2

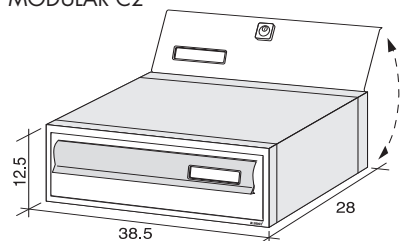

MODULAR 2 completa - MODULAR 2 complete box

## PRELIEVO POSTERIORE

(confezione 6 pezzi)

### SPORTELLO Modular SP2F

Sportello frontale per Modular 2, completo di elemento mobile, in profilato d'alluminio:

- anodizzato argento
- anodizzato bronzo
- verniciato rosso RAL 3003
- con elemento mobile grigio antracite RAL 7016
- verniciato verde RAL 6005
- con elemento mobile grigio antracite RAL 7016
- verniciato bianco RAL 9016
- verniciato grigio antracite RAL 7016
- verniciato grigio antracite RAL 7016
- con elemento mobile in ottone
- con Kit Pubblicità

### SPORTELLO Modular SP2R

- Sportello Modular SP2R retro, per Modular 2, finiture come per SP2F, completo di serratura

Tutta la Serie MODULAR viene fornita con corpo e sportelli smontati.



SP2FAR



SP2FBR



SP2FRO / el. mob. GH - Ral 7016



SP2FVE / el. mob. GH - Ral 7016



SP2FBI

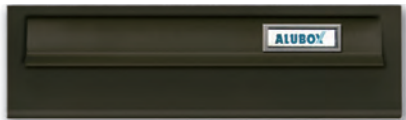

SP2FGH - Ral 7016

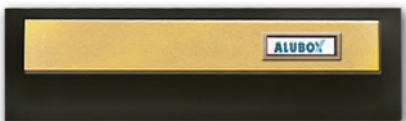

SP2OTT con elemento mobile in ottone  
SP2OTT with polished brass flap



SP1PUB con kit pubblicità (vedi pag. 88)  
SP1PUB with publicity kit (see page 88)

## REAR ACCESS

(6-pieces package)

### MODULAR SP2F DOOR

Aluminium profile front door for Modular 2, complete with flap:

- anodized - silver
- anodized - bronze
- painted in RAL 3003 red, with anthracite color RAL 7016 flap
- painted in RAL 6005 green, with anthracite color RAL 7016 flap
- painted in RAL 9016 white
- painted in anthracite color RAL 7016
- painted in anthracite color RAL 7016 with brass flap
- with publicity kit

### Modular SP2R DOOR

- Rear door Modular SP2R for Modular 2. Same finishes as SP2F, complete with lock

MODULAR series mailboxes are supplied in loose form ready for assembly.

### MODULAR 200/2

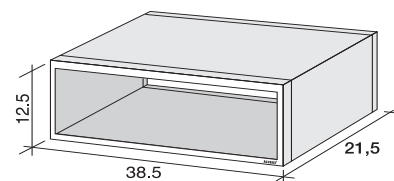

**C2002** • Corpo per cassetta componibile in alluminio con profondità 21,5 cm.  
SOLO DA INCASSO CON CORNICE  
**NON CONFORME ALLE NORMATIVE EN 13724**

**C2002** • Body for modular mailbox aluminium with 21.5 cms depth.  
**ONLY FOR RECESS MOUNTING WITH EXTERNAL FRAME.**  
**NOT IN ACCORDANCE WITH EUROPEAN STANDARD RULES EN 13724**



### MODULAR 2 ACC

Cassetta completa bifrontale da incasso passante, in alluminio colore testa di moro e sportello porta accessori predisposto per l'inserimento di campanelli, telecamera, citofono e numero civico per i modelli BTicino Sfera. Accessori vedi da pag. 42.

### MODULAR 2 ACC

Complete through mounting double-sided mailbox, in dark brown oxi-anodized aluminium and accessories panel designed for incorporating doorbells, video camera, intercom and residence number for models BTicino Sfera. Accessories, see from page 42.



AM1 - Kit anti-vandalo con chiusura in tre punti per modello SP2R.  
AM1 - Anti-vandal kit with three-point lock for SP2R door.



(confezione da 1 pezzo)

**CORPO DOPPIO**  
con sportello pubblicità con 2 sportelli, fronte e retro.

(1-pieces package)  
**DOUBLE HEIGHT BOX**  
with publicity door, rear and front door.

Serie MODULAR 2 verticale  
esempi di installazioni possibili

MODULAR 2 vertical Series  
examples of possible installations

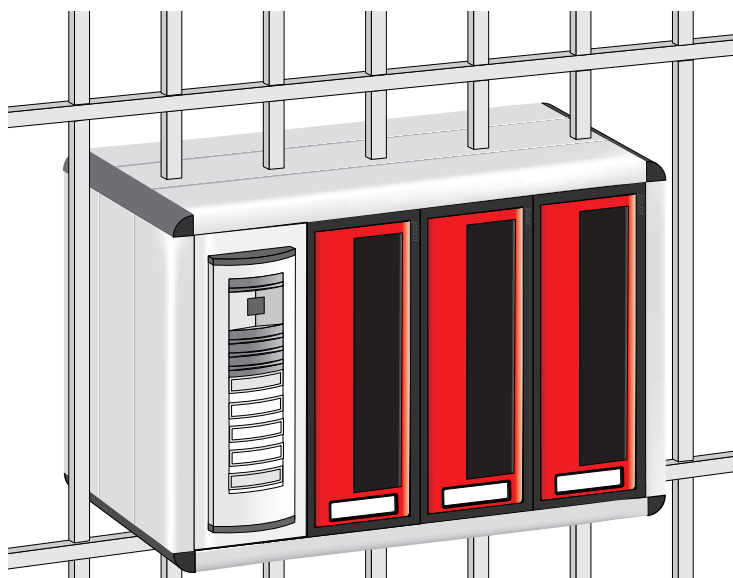
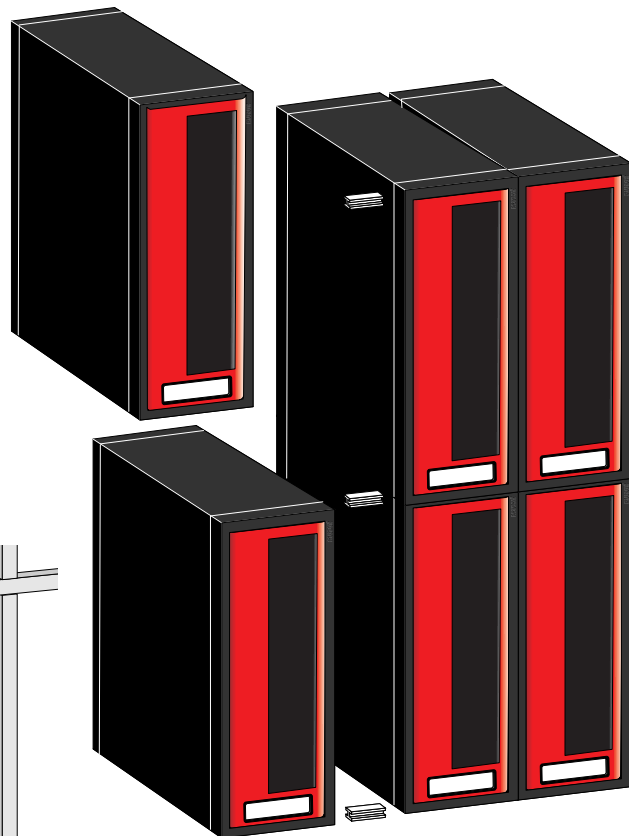
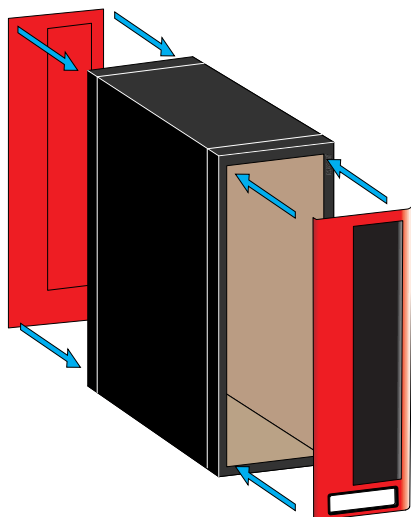

Composizione con mantello da recinzione  
Configuration with outer casing for fence mounting

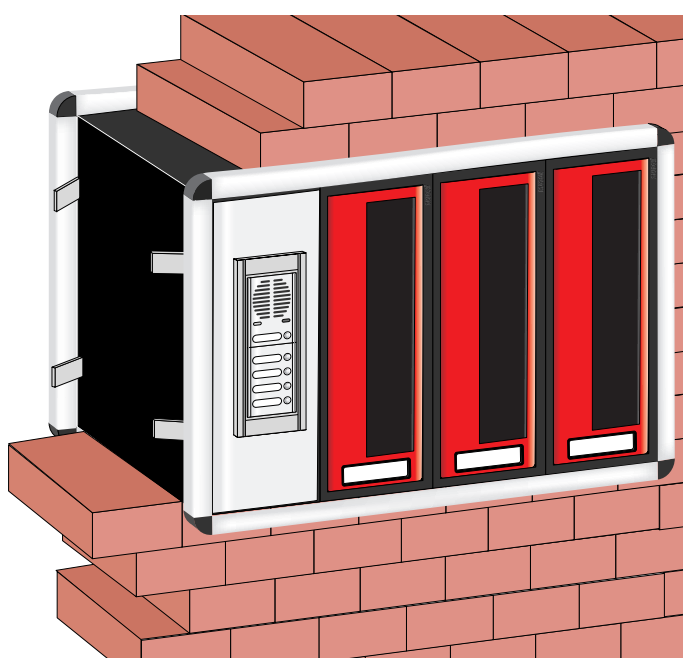
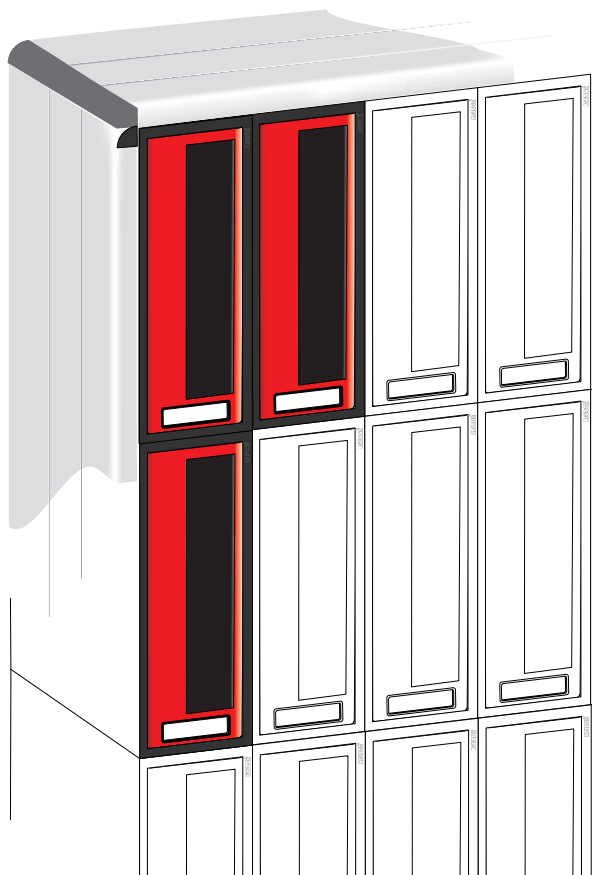

Composizione da incasso con doppia cornice  
Recessed mounting set with double external frame

# Serie MODULAR 2 - 200/2 VERTICALE

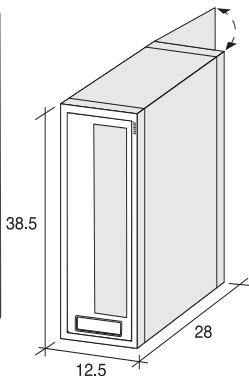

Esempio cassetta Modular 2V:  
Corpo (C2) + Sportello (SP2F)  
Example of Modular 2V mailbox:  
Body (C2) + Door (SP2F)

Modular 2V completa  
Modular 2V complete box

## PRELIEVO POSTERIORE

(confezione 6 pezzi)

### SPORTELLINO Modular SP2VF

Sportello per Modular 1 verticale completo di elemento mobile, in profilato d'alluminio:

- anodizzato argento
- anodizzato bronzo
- verniciato rosso RAL 3003 con elemento mobile grigio antracite RAL 7016
- verniciato verde RAL 6005 con elemento mobile grigio antracite RAL 7016
- verniciato bianco RAL 9016
- verniciato grigio antracite RAL 7016

### SPORTELLINO Modular SP2VR

Sportello Modular SP2VR retro, per Modular 2, finiture come per SP2VF, completo di serratura

Tutta la Serie MODULAR viene fornita con corpo e sportelli smontati.

## REAR ACCESS

(6-pieces package)

### MODULAR SP2VF DOOR

Aluminium profile door for vertical Modular 1, complete with flap:

- anodized - silver
- anodized - bronze
- painted in RAL 3003 red, with anthracite color RAL 7016 flap
- painted in RAL 6005 green, with anthracite color RAL 7016 flap
- painted in RAL 9016 white
- painted in anthracite color RAL 7016

### Modular SP2VR DOOR

Rear door Modular SP2VR for Modular 2. Same finishes as SP2VF, complete with lock

MODULAR series mailboxes are supplied in loose form ready for assembly.



Modular C2 CGH con cornice di plastica grigio antracite with anthracite color plastic frame



Modular C2 CAR con cornice di plastica argento with silver plastic frame



Modular C2 CBI con cornice di plastica bianca with white plastic frame

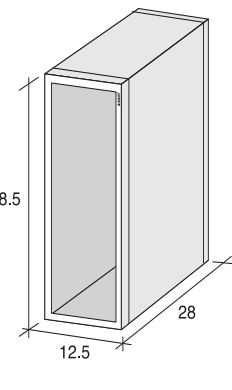

Modular C2



SP2V FAR



SP2V FBR



SP2V FRO el. mob. GH RAL 7016



SP2V FE el. mob. GH RAL 7016



SP2V FBI



SP2V FGH

MODULAR 202/2

C2002 • Corpo per cassetta componibile in alluminio con profondità 21,5 cm.  
**SOLO DA INCASSO CON CORNICE**  
**NON CONFORME ALLE NORMATIVE EN 13724**

C2002 • Body for modular mailbox aluminium with 21.5 cms depth.  
**ONLY FOR RECESS MOUNTING WITH EXTERNAL FRAME.**  
**NOT IN ACCORDANCE WITH EUROPEAN STANDARD RULES EN 13724**

(confezione da 6 pezzi)

## CORPO MODULAR 1 PRELIEVO POSTERIORE

C2 • Corpo per cassetta componibile in alluminio

C2F • Corpo per cassetta componibile in lamiera elettrozincata

(6-pieces package)

## MODULAR 1 BODY

### REAR ACCESS

C2 • Body for modular mailbox - aluminium

C2F • Body for modular mailbox electrogalvanized sheet steel



SP2VF Fronte - Front view



SP2VR Retro - Rear view

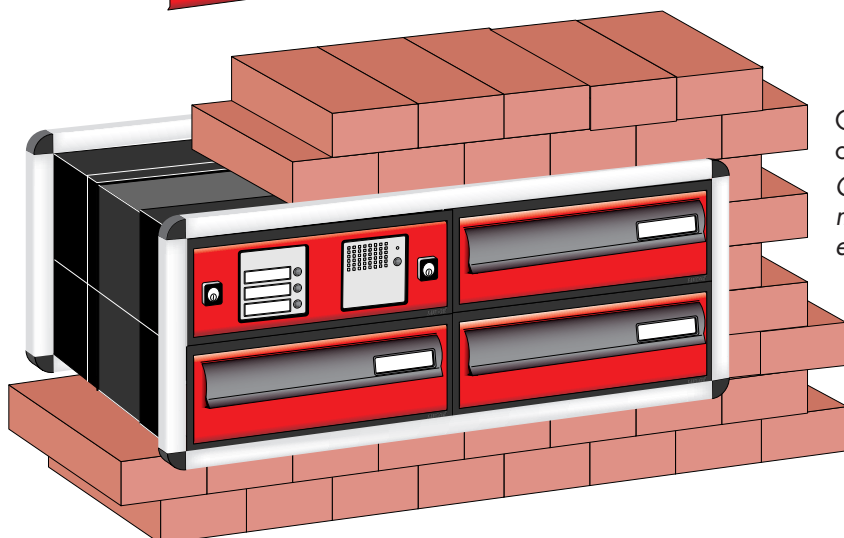
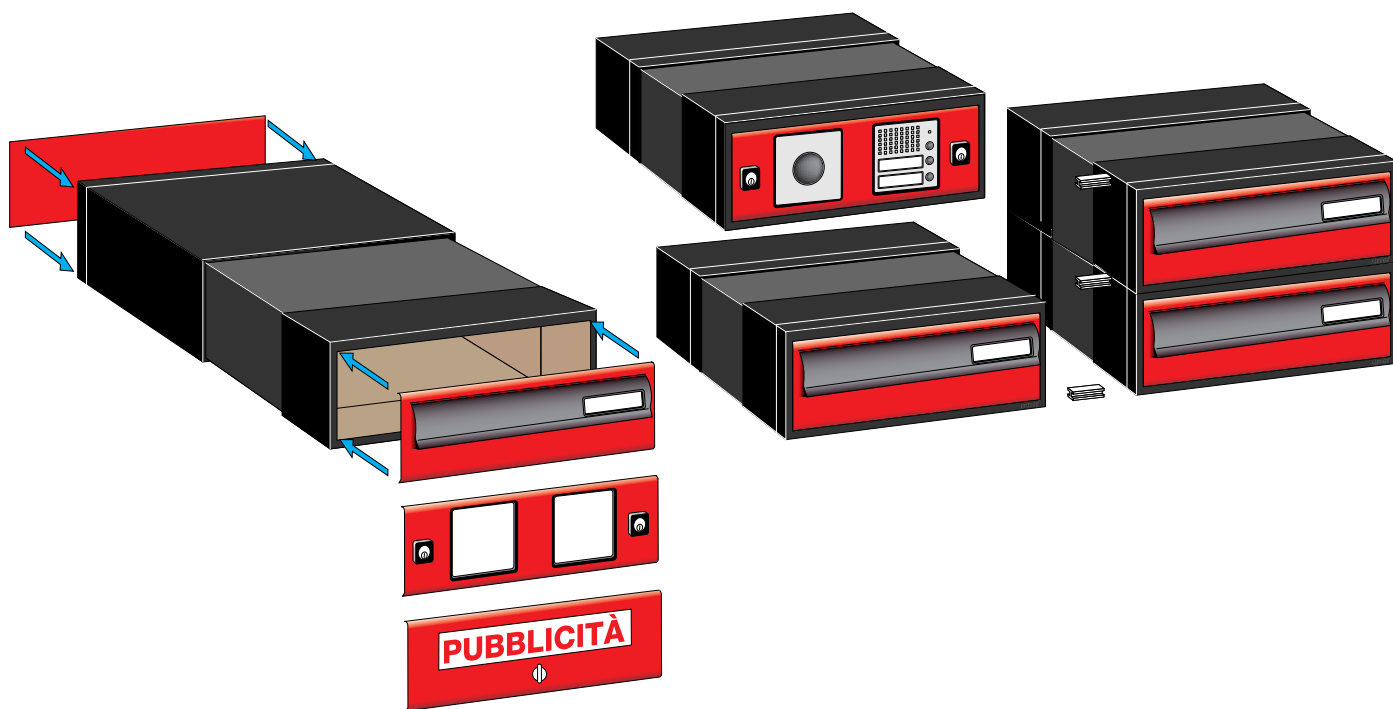

Composizione da incasso  
con doppia cornice coprifuga  
Configuration for recessed  
mounting with double  
external frame

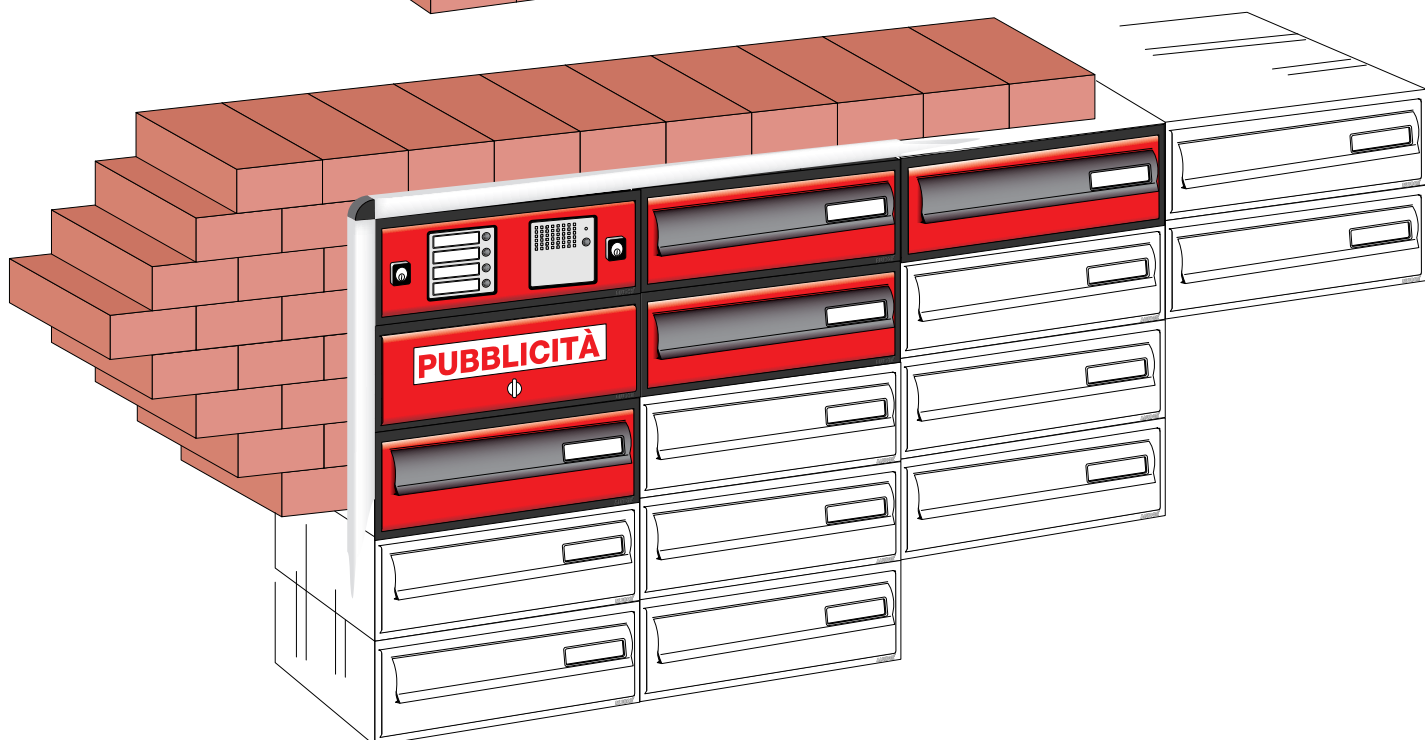



Modular 2 T CGH completa con cornice di plastica grigio antracite  
Modular 2 T CGH complete box with anthracite color plastic frame



Modular 2 T CAR completa con cornice di plastica argento  
Modular 2 T CAR complete box with silver plastic frame



Modular 2 T CBI completa con cornice di plastica bianca  
Modular 2 T CBI complete box with white plastic frame



(confezione da 6 pezzi)  
**CORPO MODULAR 2T**  
**PRELIEVO POSTERIORE**  
C2T • Corpo per cassetta componibile bifrontale  
in lamiera elettrozincata

(6-pieces package)  
**MODULAR 2T BODY**  
**REAR ACCESS**

C2T • Body for double-sided through  
mounting modular mailbox  
electrogalvanized sheet steel

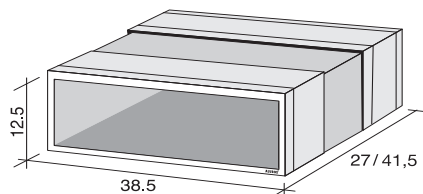

MODULAR 2T

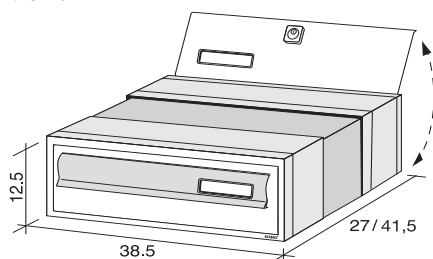

MODULAR 2T completa - MODULAR 2T complete box

**MODULAR TELESCOPICA:**  
cassetta bifrontale da incasso con corpo a profondità variabile: da un minimo di cm 27,5 a un massimo di cm 43 di spessore del muro.

Disponibile anche la versione VERTICALE  
(vedi pag 29 per sportelli)

## PRELIEVO POSTERIORE

(confezione 6 pezzi)

### SPORTELLO SP2F per Modular 2T

Sportello frontale per Modular 2T, completo di elemento mobile, in profilato d'alluminio:

- anodizzato argento
- anodizzato bronzo
- verniciato rosso RAL 3003  
con elemento mobile grigio antracite RAL 7016
- verniciato verde RAL 6005  
con elemento mobile grigio antracite RAL 7016
- verniciato bianco RAL 9016
- verniciato grigio antracite RAL 7016
- verniciato grigio antracite RAL 7016  
con elemento mobile in ottone
- con Kit Pubblicità

### SPORTELLO Modular SP2R

- Sportello Modular SP2R retro, per Modular 2T, finiture come per SP2F completa di serratura

Tutta la Serie MODULAR viene fornita con corpo e sportelli smontati.



SP2FAR



SP2FBR



SP2FRO / el. mob. GH - Ral 7016



SP2FVE / el. mob. GH - Ral 7016



SP2FBI

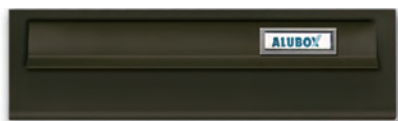

SP2FGH - Ral 7016

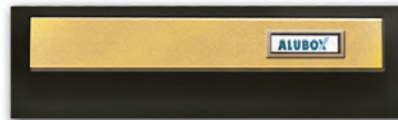

SP20TT con elemento mobile in ottone  
SP20TT with polished brass flap

**MODULAR TELESCOPICA:**  
two-sided recessed mounted mail box with body of varying depth suitable for a wall depth ranging from 27.5 cm to 43 cm.

Also available in VERTICAL edition  
(please see pag 29 for doors)

## REAR ACCESS

(6-pieces package)

### DOOR SP2F for Modular 2T

Aluminium profile front door for Modular 2T, complete with flap:

- anodized - silver
- anodized - bronze
- painted in RAL 3003 red,  
with anthracite color RAL 7016 flap
- painted in RAL 6005 green,  
with anthracite color RAL 7016 flap
- painted in RAL 9016 white
- painted in anthracite color RAL 7016
- painted in anthracite color RAL 7016 with brass flap
- with publicity kit

### Modular SP2R DOOR

- Rear door Modular SP2R for Modular 2T. Same finishes as SP2F, complete with lock

MODULAR series mailboxes are supplied in loose form ready for assembly.



SP1PUB con kit pubblicità (vedi pag. 88)  
SP1PUB with publicity kit (see page 88)



**MODULAR 2 ACC**  
Cassetta completa bifrontale da incasso passante, in lamiera elettrozincata e sportello porta accessori predisposto per l'inserimento di campanelli, telecamera, citofono e numero civico per i modelli BTicino Sfera. Accessori vedi da pag. 42.  
Finiture: vedi sportello Modular 2T

### MODULAR 2 ACC

Complete through mounting double-sided mailbox, in electrogalvanized sheet steel and accessories panel designed for incorporating doorbells, video camera, intercom and residence number for models BTicino Sfera. Accessories, see from page 42.

Types of finish: see Modular 2T door



AM1 - Kit antivandalo con chiusura a tre punti per modello SP2R.  
AM1 - Anti-vandal kit with three-point lock for SP2R door.





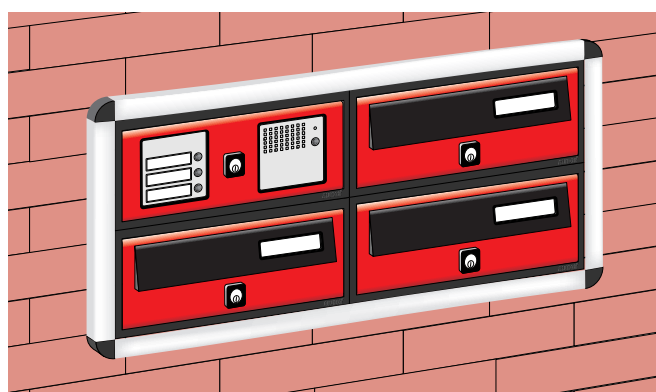
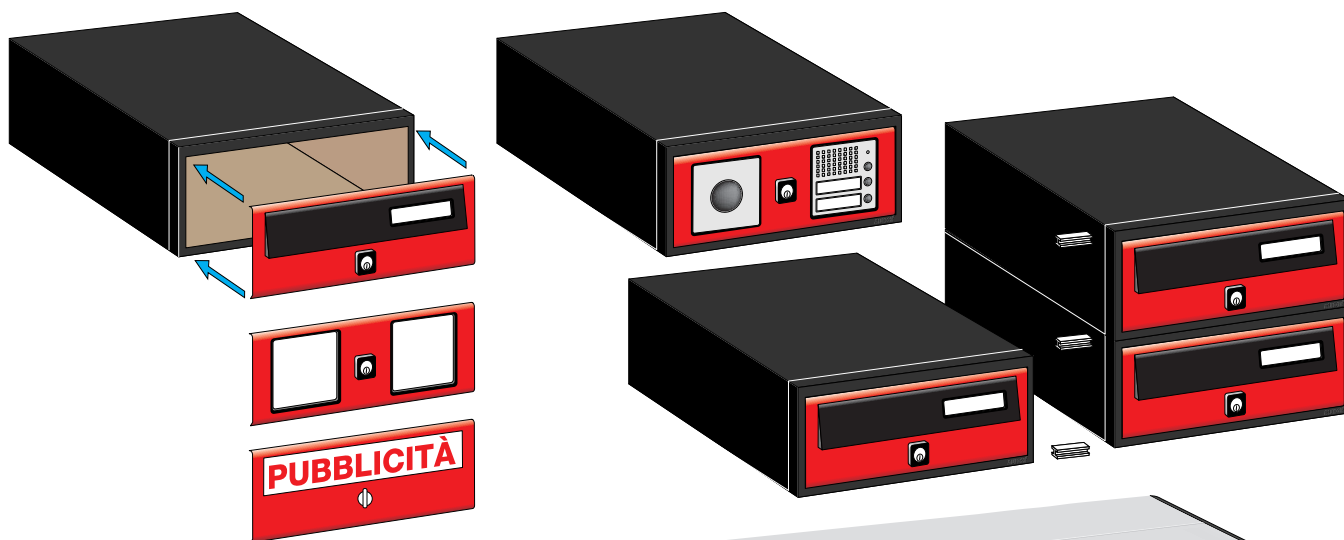

Composizione da incasso con cornice coprifuga  
 Configuration for recessed mounting with external frame



Composizione con mantello per esterni  
 Configuration with outer casing for outdoors

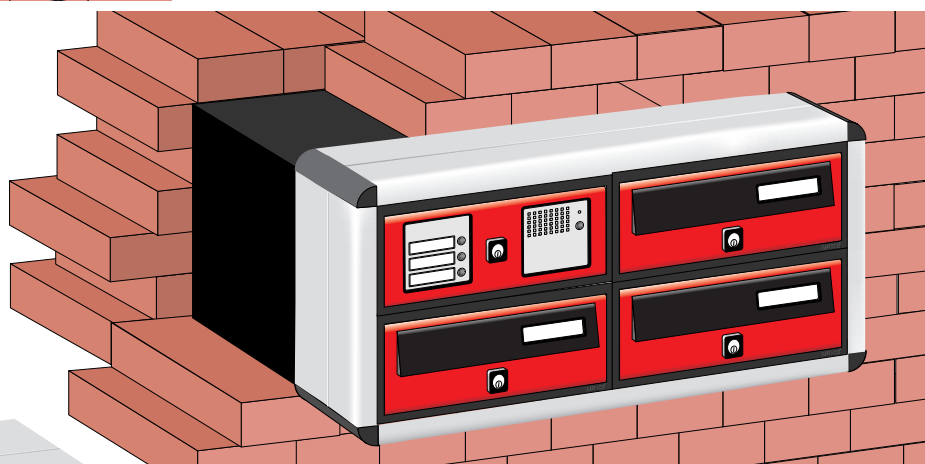

Composizione semincasso con mantello  
 Configuration with outer casing for semi-recessed mounting

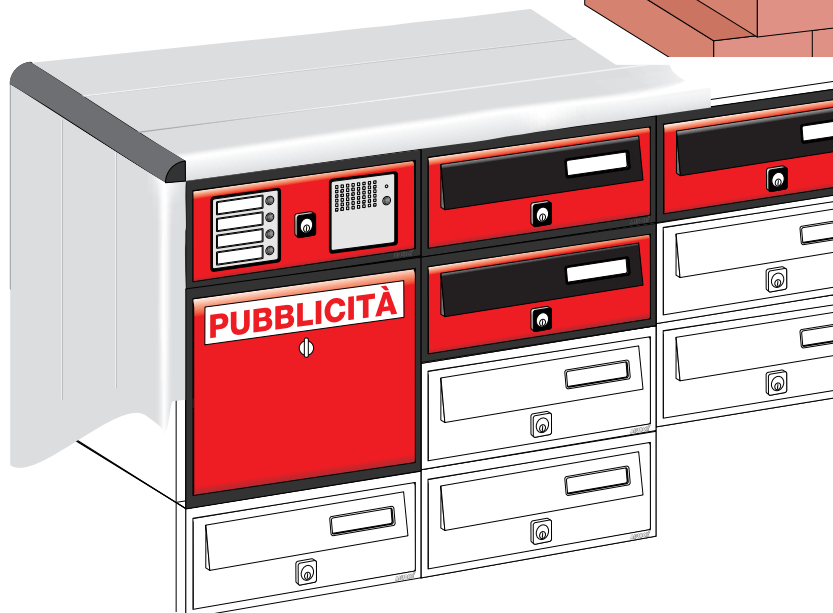

Composizione con mantello, sportello SP270 ACC predisposto per l'inserimento di campanelli, telecamera, citofono e numero civico per i modelli BTicino Sfera e corpo doppio pubblicità. Accessori vedi da pag. 42.

Example of configuration with outer casing, composed to SP270 ACC door suitable for door bells, videocamera, intercom, residence number for BTicino Sfera brand and double box for advertising. Accessories, see page 42.

Serie **MODULAR 270 - 240/1**

Modular C270 CGH  
con cornice di plastica grigio antracite - *with anthracite color plastic frame*



Modular C270 CAR  
con cornice di plastica argento - *with silver plastic frame*



Modular C270 CBI  
con cornice di plastica bianca - *with white plastic frame*

(confezione da 6 pezzi)  
**CORPO MODULAR C270**  
**PRELIEVO FRONTALE**

- C270** • Corpo per cassetta componibile in **alluminio**  
**C270F** • Corpo per cassetta componibile in **lamiera elettrozincata**

(6-pieces package)  
**MODULAR C270 BODY**  
**FRONT ACCESS**

- C270** • Body for modular mailbox **aluminium**  
**C270F** • Body for modular mailbox **electrogalvanized sheet steel**

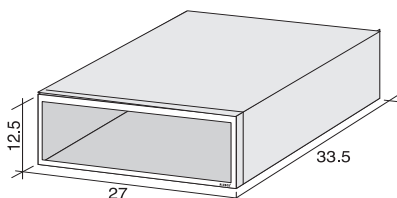

MODULAR C270

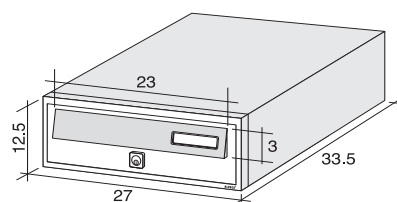

MODULAR 270 completa  
MODULAR 270 complete box

**Modello con profondità maggiore e larghezza inferiore rispetto alla Modular 1 per consentire di utilizzare spazi ridotti.**

**PRELIEVO FRONTALE**

(confezione 6 pezzi)

**SPORTELLO Modular SP270/1**

**Sportello per Modular 270/1 completo di elemento mobile, in profilato d'alluminio.**

- anodizzato argento
- anodizzato bronzo
- verniciato rosso RAL 3003 con elemento mobile grigio antracite RAL 7016
- verniciato verde RAL 6005 con elemento mobile grigio antracite RAL 7016
- verniciato bianco RAL 9016
- verniciato grigio antracite RAL 7016
- verniciato grigio antracite RAL 7016 con elemento mobile in ottone
- con Kit Pubblicità

**Tutta la Serie MODULAR viene fornita con corpo e sportelli smontati.**



SP270/1AR



SP270/1BR



SP270/1RO / el. mob. GH - Ral 7016



SP270/1VE / el. mob. GH - Ral 7016



SP270/1BI



SP270/1GH

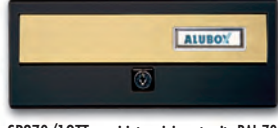

SP270/1OTT verniciato grigio antracite RAL 7016 con elemento mobile in ottone.  
SP270/1OTT painted in anthracite color RAL 7016 with polished brass flap



SP270/PUB  
con kit pubblicità (vedi pag. 88) - *with publicity kit (see page 88)*

**Model with greater depth and narrower width than Modular 1 in order to use smaller areas.**

**FRONT ACCESS**

(6-pieces package)

**Modular SP270/1 DOOR**

**Aluminium profile door for Modular 270/1, complete with flap:**

- anodized - silver
- anodized - bronze
- painted in RAL 3003 red, with anthracite color RAL 7016 flap
- painted in RAL 6005 green, with anthracite color RAL 7016 flap
- painted in RAL 9016 white
- painted in anthracite color RAL 7016
- painted in anthracite color RAL 7016 with brass flap
- with publicity kit

**MODULAR series mailboxes are supplied in loose form ready for assembly.**

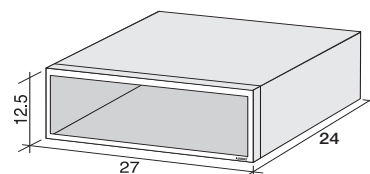
**MODULAR 240/1**

- C2401** • Corpo per cassetta componibile in **alluminio con profondità 24 cm.**  
**SOLO DA INCASSO CON CORNICE**  
**NON CONFORME ALLE NORMATIVE EN 13724**

- C2401** • Body for modular mailbox **aluminium with 24 cms depth.**  
**ONLY FOR RECESS MOUNTING WITH EXTERNAL FRAME.**  
**NOT IN ACCORDANCE WITH EUROPEAN STANDARD RULES EN 13724**

**SPORTELLO SP270 ACC**

Sportello Serie MODULAR 270 in profilato d'alluminio predisposto per l'inserimento di campanelli, telecamera, citofono e numero civico per i modelli BTicino Sfera. Accessori vedi da pag. 42. **Finiture: vedi SP1/270**

**SP270 ACC DOOR**

MODULAR 270 series panel in aluminium profile designed for incorporating doorbells, video camera, intercom and residence number for models BTicino Sfera. Accessories, see from page 42.

**Types of finish: see SP270 door**



- (confezione da 1 pezzo)  
**CORPO DOPPIO**  
con sportello pubblicità.  
(1-piece package)  
**DOUBLE HEIGHT**  
**BOX** with  
publicity door.

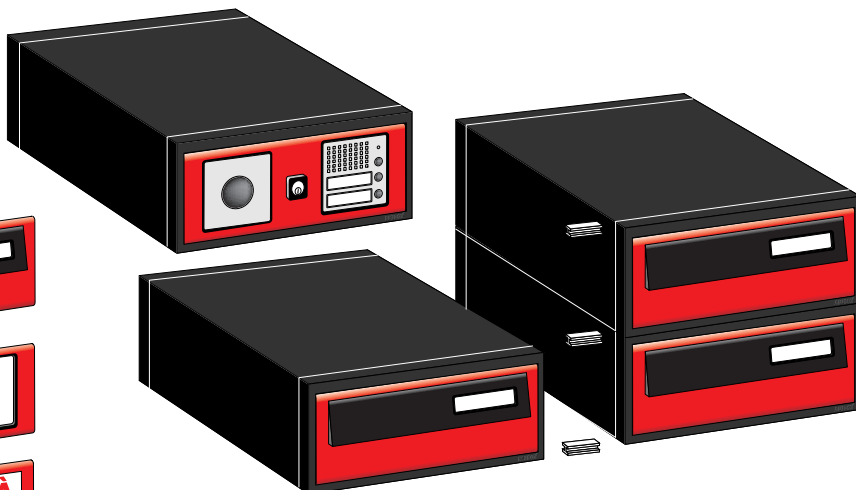
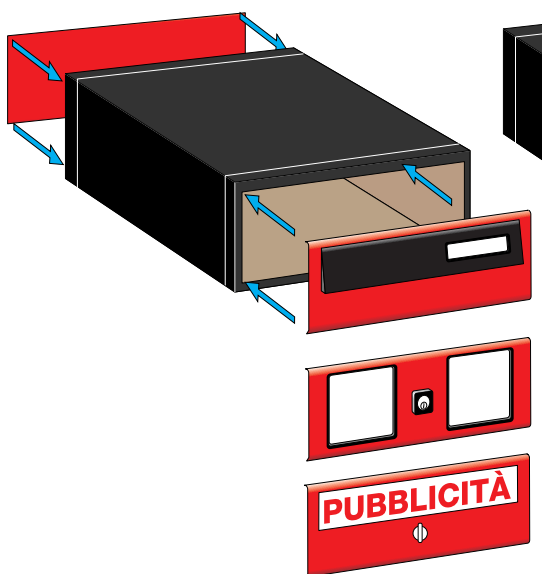

Composizione con mantello da recinzione  
Configuration with outer casing for fence mounting

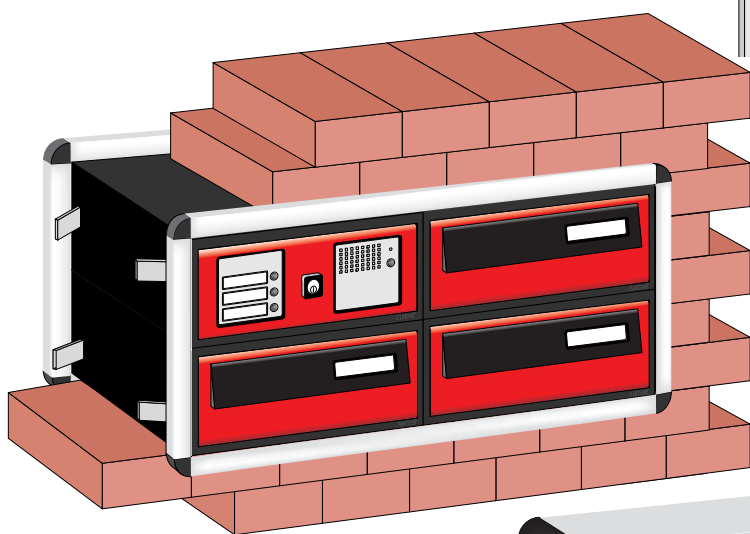
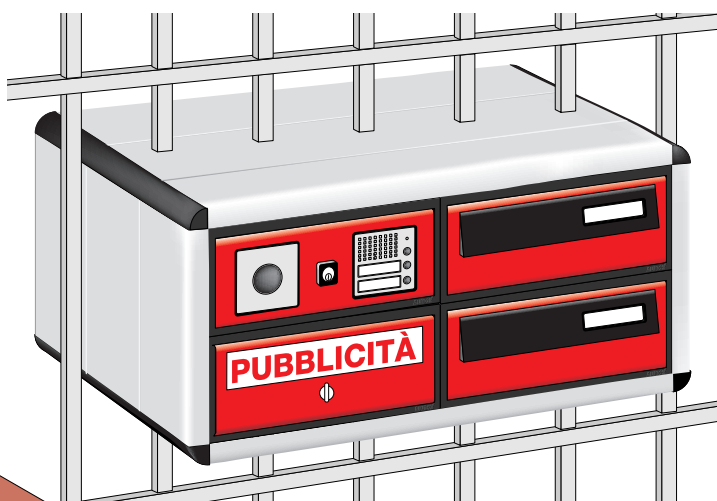

Composizione da incasso con doppia cornice  
Configuration for recessed mounting  
with double external frame

Composizione con mantello, sportello SP1 270 ACC predisposto per l'inserimento di campanelli, telecamera, citofono e numero civico per i modelli BTicino Sfera e corpo doppio pubblicità. Accessori vedi da pag. 42.

Example of configuration with outer casing, composed to SP1 270 ACC door suitable for door bells videocamera intercom, residence number for BTicino Sfera brand and double box for advertising. Accessories, see page 42.



Serie **MODULAR 270/2 - 240/2****SP270/2F**

Fronte - Front view

**SP270/2R**

Retro - Rear view

**Modular C270/2 CGH**con cornice di plastica grigio antracite *with anthracite color plastic frame***Modular C270/2 CAR**con cornice di plastica argento *-with silver plastic frame***Modular C270/2 CBI**con cornice di plastica bianca *-with white plastic frame*

(confezione da 6 pezzi)

**CORPO MODULAR C270/2****PRELIEVO POSTERIORE****C270/2** • Corpo per cassetta componibile in alluminio**C270/2F** • Corpo per cassetta componibile in lamiera elettrozincata

(6-pieces package)

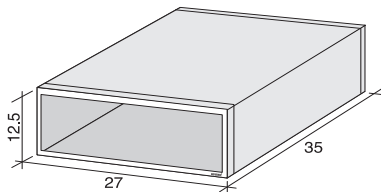
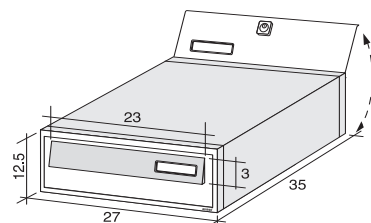
**MODULAR C270/2 BODY****REAR ACCESS****C270/2** • Body for modular mailbox aluminium**C270/2F** • Body for modular mailbox electrogalvanized sheet steel**MODULAR C270/2****MODULAR 270/2 completa**  
**MODULAR 270/2 complete box**

**Modello con profondità maggiore e larghezza inferiore rispetto alla Modular 2 per consentire di utilizzare spazi ridotti.**

**PRELIEVO POSTERIORE**

(confezione 6 pezzi)

**SPORTELLO Modular SP270/2F****Sportello frontale per Modular 270/2 completo di elemento mobile, in profilato d'alluminio:**

- anodizzato argento
- anodizzato bronzo
- verniciato rosso RAL 3003 con elemento mobile grigio antracite RAL 7016
- verniciato verde RAL 6005 con elemento mobile grigio antracite RAL 7016
- verniciato bianco RAL 9016
- verniciato grigio antracite RAL 7016
- verniciato grigio antracite RAL 7016 con elemento mobile in ottone
- con Kit Pubblicità

**SPORTELLO Modular SP270/2R**

- Sportello Modular SP270/2R retro, per Modular 270/2 finiture come per SP270/2F completa di serratura.

**Tutta la Serie MODULAR viene fornita con corpo e sportelli smontati.**

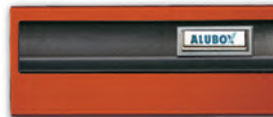
**SP270/2FAR****SP270/2FBR****SP270/2FRO / el. mob. GH - Ral 7016****SP270/2FVE / el. mob. GH - Ral 7016****SP270/2FBI****SP270/2FGH - Ral 7016****SP270/2FOTT verniciato grigio antracite RAL 7016 con elemento mobile in ottone.**  
**SP270/2FOTT painted in anthracite color RAL 7016 with polished brass flap****SP270/PUB**  
con kit pubblicità (vedi pag. 88) - *ith publicity kit (see page 88)*

**Model with greater depth and narrower width than Modular 2 in order to use smaller areas.**

**REAR ACCESS**

(6-pieces package)

**Modular SP270/2F DOOR****Aluminium profile front door for Modular 270/2, complete with flap:**

- anodized - silver
- anodized - bronze
- painted in RAL 3003 red, with anthracite color RAL 7016 flap
- painted in RAL 6005 green, with anthracite color RAL 7016 flap
- painted in RAL 9016 white
- painted in anthracite color RAL 7016
- painted in anthracite color RAL 7016 with brass flap
- with publicity kit

**Modular SP270/2R DOOR**

- Rear door Modular SP270/2R for Modular 270/2 Same finishes as SP270/2F, complete with lock.

**MODULAR series mailboxes are supplied in loose form ready for assembly.**

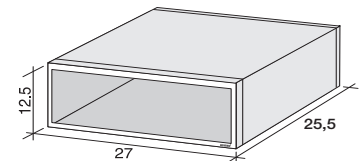
**MODULAR 240/2****C2402** • Corpo per cassetta componibile in alluminio con profondità 25,5 cm.**SOLO DA INCASSO CON CORNICE****NON CONFORME ALLE NORMATIVE EN 13724****C2402** • Body for modular mailbox aluminium with 25.5 cms depth.**ONLY FOR RECESS MOUNTING WITH EXTERNAL FRAME.**  
**NOT IN ACCORDANCE WITH EUROPEAN STANDARD RULES EN 13724****SPORTELLO SP270 ACC**

Sportello Serie MODULAR 270 in profilato d'alluminio predisposto per l'inserimento di campanelli, telecamera, citofono e numero civico per i modelli BTicino Sfera.

Accessori vedi da pag. 42. **Finiture: vedi SP1/270****SP270 ACC DOOR**

MODULAR 270 series panel in aluminium profile designed for incorporating doorbells, video camera, intercom and residence number for BTicino Sfera. Accessories: see page 42.

**Types of finish: see SP270 door**

(confezione da 1 pezzo)

**CORPO DOPPIO**

con sportello pubblicità con 2 sportelli, fronte e retro.

(1-pieces package)

**DOUBLE HEIGHT BOX**

with publicity door, rear and front door.

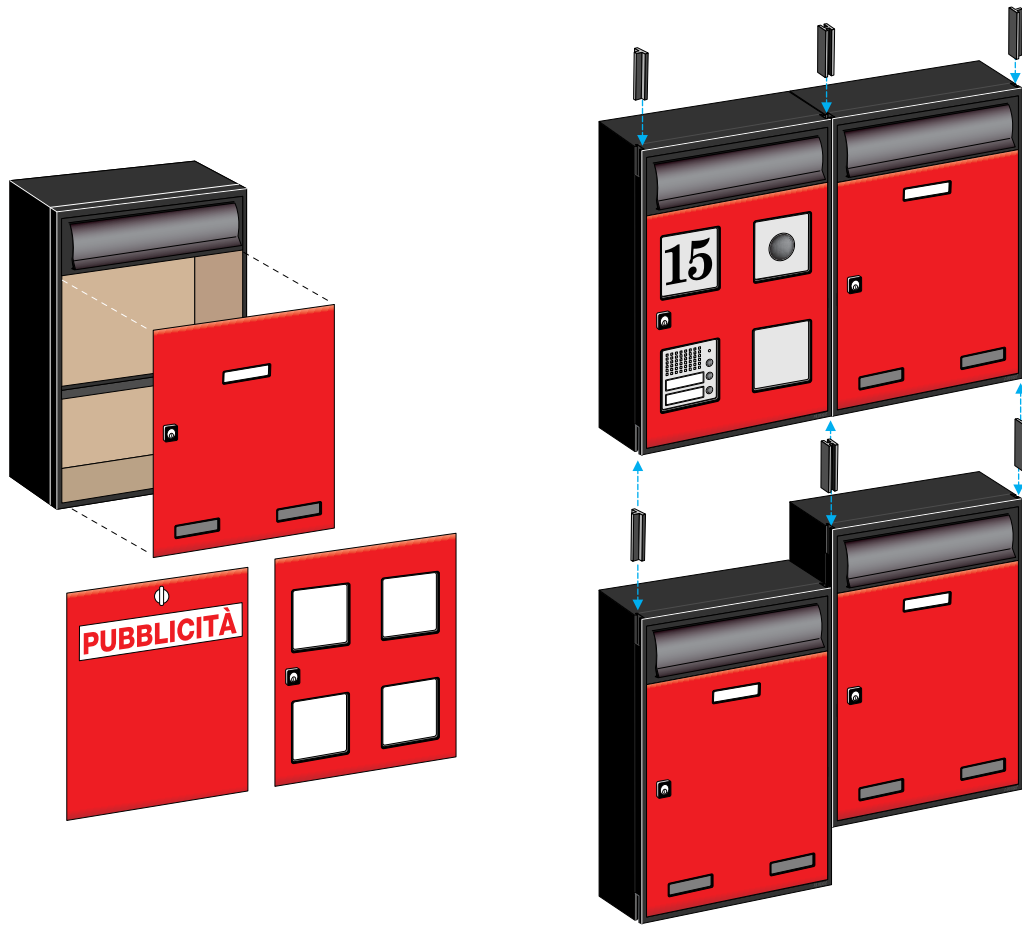

Composizione con mantello  
Configuration with outer casing



Composizione da incasso con cornice coprifuga  
Configuration for recess mounting with cover frame

# Serie MODULAR 3



MODULAR 3 completa - MODULAR 3 complete box

## PRELIEVO FRONTALE

(confezione 6 pezzi)

### SPORTELLO Modular SP3

Sportello per Modular 3 in alluminio:

- anodizzato argento
- anodizzato bronzo
- verniciato grigio antracite RAL 7016
- verniciato rosso RAL 3003
- verniciato verde RAL 6005
- verniciato bianco RAL 9016
- con Kit Pubblicità

Tutta la Serie Modular viene fornita con corpo e sportelli smontati.

## FRONT ACCESS

(6-pieces package)

### Modular SP3 DOOR

Aluminium Modular 3 door:

- anodized - silver
- anodized - bronze
- painted in anthracite color RAL 7016
- painted in RAL 3003 red
- painted in RAL 6005 green
- painted in RAL 9016 white
- with publicity kit

Modular series mailboxes are supplied in loose form ready for assembly.



Modular C3 CGH con cornice di plastica grigio antracite ed el. mob. color grigio antracite with anthracite color plastic frame and anthracite color flap



Modular C3 CAR con cornice di plastica argento ed el. mob. color argento with silver plastic frame and silver flap



Modular C3 CBI con cornice di plastica bianca ed el. mob. color bianco with white plastic frame and white flap

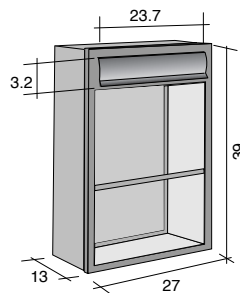

MODULAR C3

(confezione 6 pezzi)

### MODULAR C3 FRONTALE

Corpo per cassetta componibile passante in alluminio completo di elemento mobile in profilato d'alluminio.

(6-pieces package)

### MODULAR C3 FRONT ACCESS

Aluminium body for through mounting modular mailbox complete with aluminium profile flap.



SP3AR



SP3BR



SP3VE



SP3RO



SP3BI



SP3GH - Ral 7016



SP3PUB con kit pubblicità (vedi pag. 88) with publicity kit (see page 88)

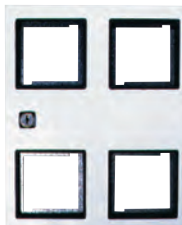

**SP3 ACC**  
Sportello in alluminio porta accessori BTicino Sfera (vedi pag. 42).  
Finiture: vedi Modular SP3

**SP3 ACC**  
Aluminium accessories panel for BTicino Sfera brand. (see page 42).  
Types of finish: see Modular SP3



**AM3**  
Kit antivandalo con chiusura in tre punti per modello SP3.  
**AM3**  
Anti-vandal kit with three-point lock for SP3 door.

# Serie MODULAR 3/2

## PRELIEVO POSTERIORE - REAR ACCESS



Retro Modular C3/2 con elemento mobile bloccato  
Modular C3/2 rear view with fastened flap



Modular C3/2 CGH con cornice di plastica grigio antracite ed el. mob. color grigio antracite with anthracite color plastic frame and anthracite color flap



Modular C3/2 CAR con cornice di plastica argento ed el. mob. color argento with silver plastic frame and silver flap



Modular C3/2 CBI con cornice di plastica bianca ed el. mob. color bianco with white plastic frame and white flap

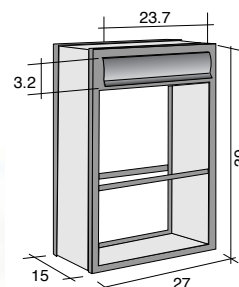

MODULAR C3/2

(confezione 6 pezzi)

### MODULAR C3/2

Corpo per cassetta componibile passante in alluminio completo di elemento mobile in profilato d'alluminio.

(6-pieces package)

### MODULAR C3/2

Aluminium body for through mounting modular mailbox complete with aluminium profile flap.

MADE IN ITALY

# Serie MODULAR

**Piantane in alluminio verniciato per Modular con mantello, Jumbo, Jumbo LUX e Slim.** (Dimensioni in cm)

**Painted aluminium support columns for Modular mailbox sets with outer casing, Jumbo, Jumbo LUX and Slim.** (Dimensions cm)

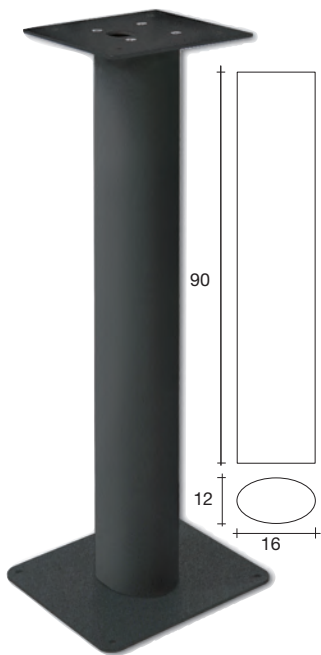

**Colori standard:**  
verniciato grigio antracite RAL 7016 e argento metallizzato.

• **A richiesta:**  
Supplemento del 25% per colori Ral, previa disponibilità presso verniciatura.

**Standard colors:**  
anthracite color RAL 7016 and metallic silver.

• **On request:**  
Additional charge of 25% for Ral colors available, subject to availability at varnisher.

## Piantana con piastra piccola. Support column with small plate.

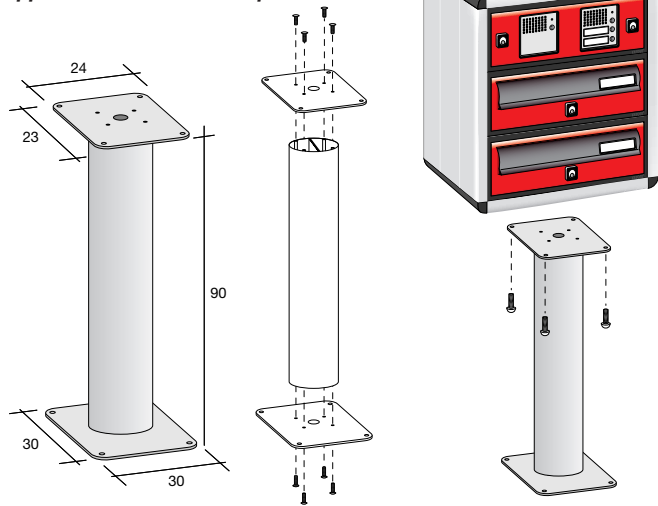

## Piantana con piastra grande. Support column with large plate.

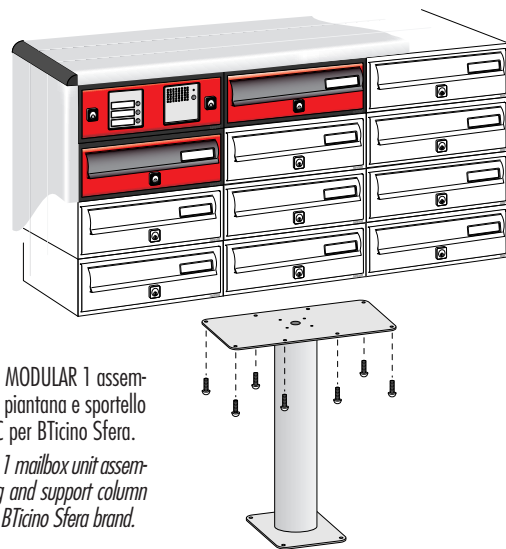
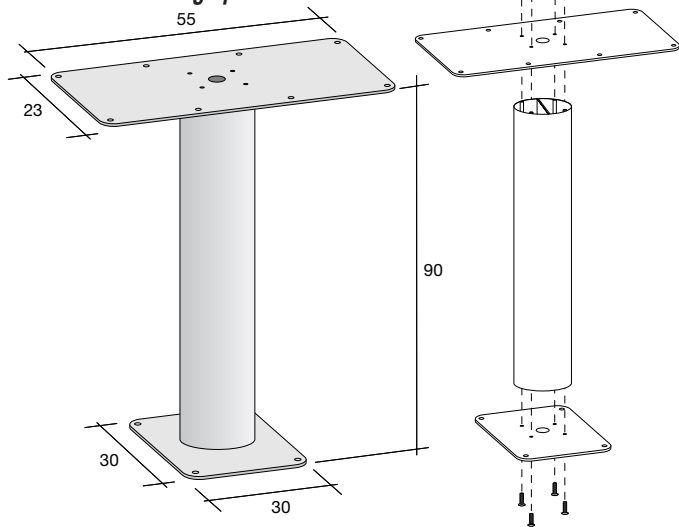

Esempio di blocciera MODULAR 1 assemblata con mantello e piantana e sportello accessorato SPT ACC per BTicino Sfera.

Example of MODULAR 1 mailbox unit assembled with outer casing and support column and SPT ACC door for BTicino Sfera brand.

## Prolungamento del mantello Extension of outer casing.



Doppia piantana in alluminio per blocciera Modular 3 con mantello  
Aluminium double support column for Modular 3 mailbox unit with outer casing.

Esempio di blocciera MODULAR 3 assemblata con mantello composta da 6 cassette postali di cui una con sportello accessorato di citofono, 5 campanelli, numero civico, completa di piantane.

Example of MODULAR 3 freestanding mailbox unit composed to 6 mailboxes, with 1 SP3 ACC suitable for intercom house number, bells for BTicino Sfera brand.

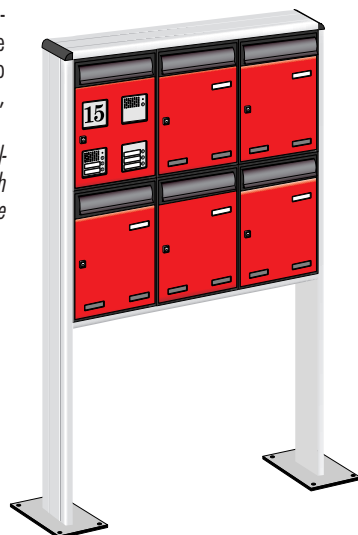

MADE IN ITALY

## Serie CURVE

Piantane in alluminio verniciato per casellari CURVE con mantello. (Dimensioni in cm)

Painted aluminium support columns for CURVE mailbox sets with outer casing. (Dimensions cm)

**COLORI RAL a richiesta senza supplemento di prezzo** (previa disponibilità presso verniciatura).

**RAL COLORS on request without additional charge** (subject to availability at varnisher).

Colori standard:

- verniciato grigio antracite RAL 7016
- verniciato ruggine
- verniciato metallizzato argento
- verniciato bianco Ral 9016

Standard colors:

- painted in RAL 7016 anthracite color
- painted in rust
- painted in metallic silver
- painted in Ral 9016 white

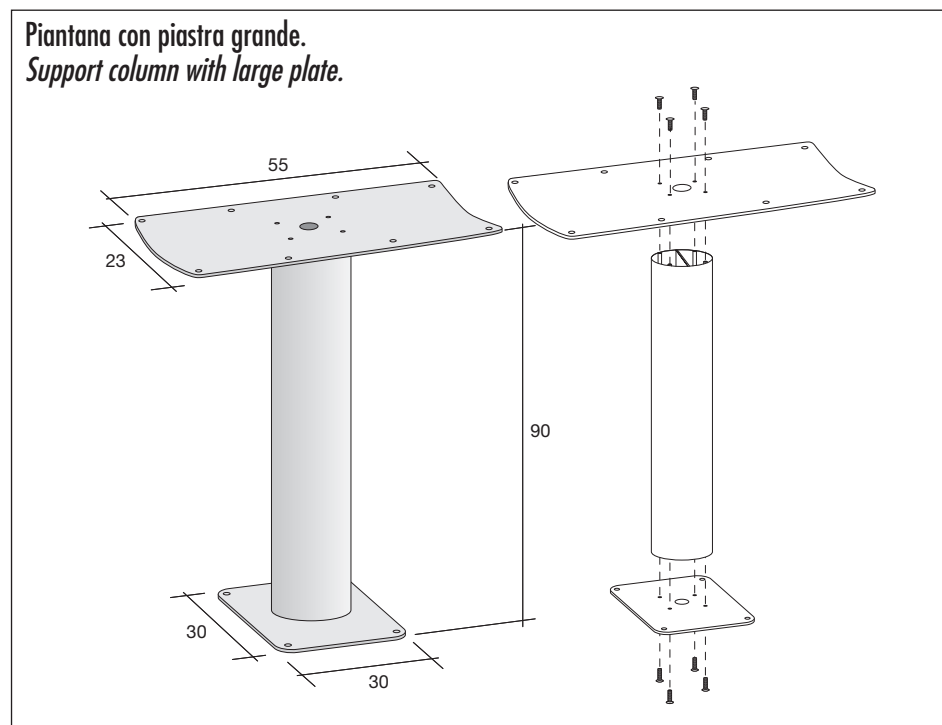
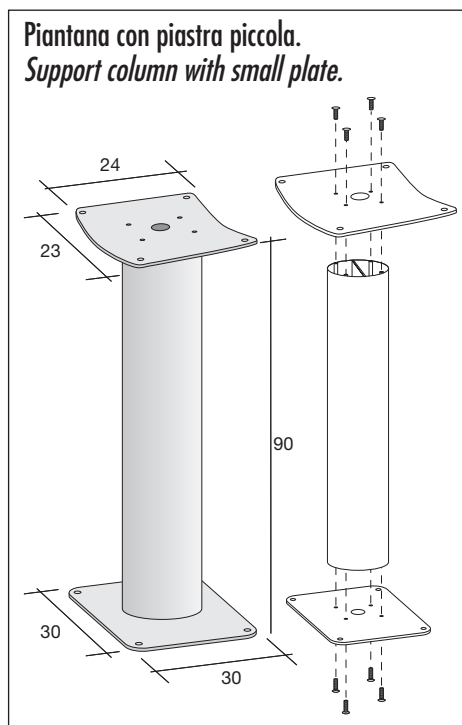

Esempi di possibili altezze delle blocchiere MODULAR e CURVE assemblate con palo.

Example of possible heights of freestanding MODULAR and CURVE Series units with column supports.

Fino ad un massimo di 6 cassette in altezza, piantana standard di cm 90.

Up to a maximum of 6 vertical mailboxes, 90 cm standard support column.

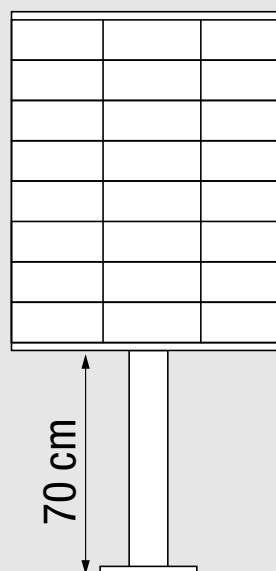
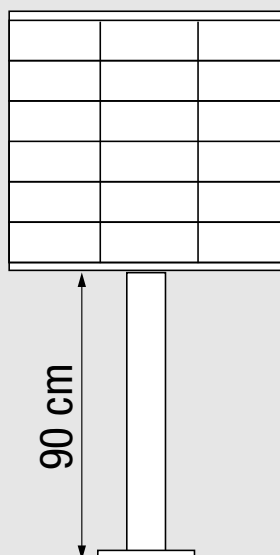
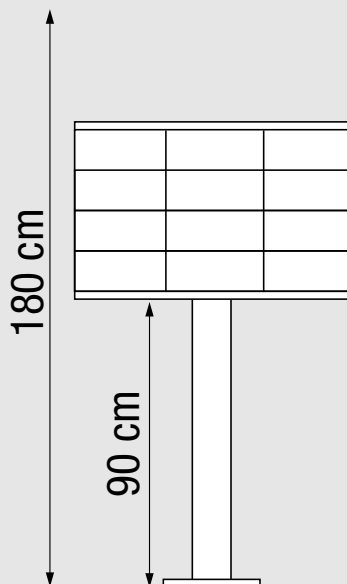



MADE IN ITALY

## Serie MODULAR

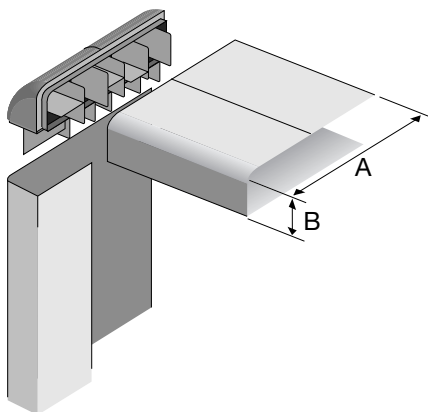

modello/model	A	B
Modular 3	150 mm	25 mm
Modular 1-Modular 2	300 mm	25 mm
Modular 270	350 mm	25 mm
Modular 270/2	400 mm	25 mm

**Mantello in profilato d'alluminio.**  
**A RICHIESTA: supplemento del 25% per colori Ral, (previa disponibilità presso verniciatura).**

- Disponibile nei colori:
- anodizzato argento
  - verniciato grigio antracite RAL 7016
  - verniciato verde RAL 6005
  - verniciato bianco RAL 9016
  - verniciato rosso RAL 3003

**Tutti i mantelli sono preforati nella parte inferiore per l'eventuale fissaggio della piantana.**

**Aluminium profile outer casing.**  
**ON REQUEST: additional charge of 25% for Ral colors available, (subject to availability at varnisher).**

- Finishes available:
- anodized - silver
  - painted in RAL 7016 anthracite color
  - painted in RAL 6005 green
  - painted in RAL 9016 white
  - painted in RAL 3003 red

**All outer casing are already predisposed to fix support column on the bottom side.**



Esempio di blocchiera MODULAR **assemblata con mantello**, composta da più cassette postali e sportello accessori.

*Example of MODULAR mailbox **unit with outer casing**, composed of various boxes and accessories panel.*

## Serie CURVE

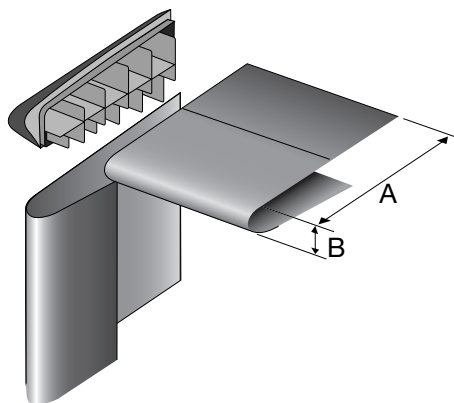

modello/model	A	B
Modular CURVE	300 mm	25 mm
Modular 2 CURVE	300 mm	25 mm

**Mantello in profilato d'alluminio.**  
**COLORI RAL a richiesta senza supplemento di prezzo (previa disponibilità presso verniciatura).**

- Disponibile nei colori:
- anodizzato argento
  - verniciato grigio antracite RAL 7016
  - verniciato ruggine
  - verniciato bianco Ral 9016
  - verniciato verde Ral 6005
  - verniciato rosso Ral 3003
  - verniciato metallizzato argento

**Tutti i mantelli sono preforati nella parte inferiore per l'eventuale fissaggio della piantana.**

**Aluminium profile outer casing.**  
**RAL COLORS on request without additional charge (subject to availability at varnisher).**

- Finishes available:
- anodized - silver
  - painted in RAL 7016 anthracite color
  - painted in rust
  - painted in Ral 9016 white
  - painted in Ral 6005 green
  - painted in Ral 3003 red
  - painted in metallic silver

**All outer casing are already predisposed to fix support column on the bottom side.**

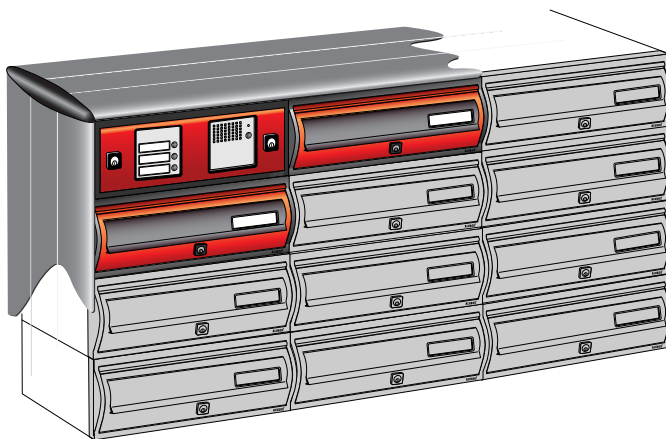

Esempio di blocchiera CURVE **assemblata con mantello**, composta da più cassette postali e sportello accessori.

*Example of CURVE mailbox **unit with outer casing**, composed of various boxes and accessories panel.*

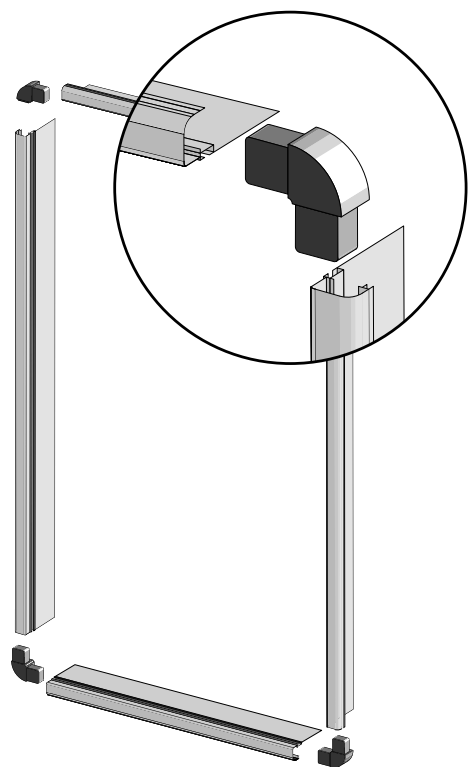

## Cornice coprifuga per Serie MODULAR

Cornice in profilato d'alluminio.  
A RICHIESTA: supplemento del 25% per colori Ral, (previa disponibilità presso verniciatura).

### Colori disponibili:

- Anodizzato argento
- Verniciato grigio antracite RAL 7016
- Verniciato bianco

## External frame for MODULAR Series

Aluminium profile external frame.  
ON REQUEST: additional charge of 25% for Ral colors available, (subject to availability at varnisher).

### Colors available:

- Anodized - silver
- Painted in RAL 7016 anthracite color
- Painted in white

## Cornice coprifuga per Serie CURVE

Cornice in profilato d'alluminio.  
COLORI RAL a richiesta senza supplemento di prezzo (previa disponibilità presso verniciatura).

### Colori disponibili:

- Anodizzato argento
- Verniciato grigio antracite RAL 7016
- Verniciato metallizzato argento
- Verniciato rosso ral 3003
- Verniciato verde ral 6005
- Verniciato bianco ral 9016
- Verniciato ruggine

## External frame for CURVE Series

Aluminium profile external frame.  
RAL COLORS on request without additional charge (subject to availability at varnisher).

### Colors available for:

- Anodized - silver
- Painted in RAL 7016 anthracite color
- Painted in metallic silver
- Painted in Ral 3003 red
- Painted in Ral 6005 green
- Painted in Ral 9016 white
- Painted in rust

## Esempi di installazione - Examples of installation

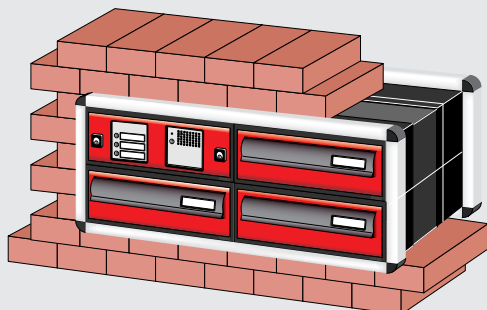

Esempio di blocchiera Modular 2T composta da 3 cassette postali ed una con sportello accessoriatto di citofono e 3 campanelli incassata nel muro e assemblata con cornice fronte e retro.

Example of MODULAR 2T mailbox set, composed of 4 boxes. One mailbox door is fitted with intercom panel and 3 doorbells. Recessed and assembled with front and rear frame.



Esempio di blocchiera Modular 3 composta da 8 cassette postali ed una con Kit pubblicità incassata nel muro, assemblata con cornice sul fronte.

Example of Modular 3 set composed to 8 mailboxes with publicity box and cover frame.



Esempio di blocchiera Modular 1 composta da 42 cassette postali incassata nel muro, assemblata con cornice sul fronte e placca porta citofono.

Example of Modular 1 set composed to 42 mailboxes with cover frame and intercom panels.



Esempio di blocchiera Curve composta da 10 cassette postali e corpo doppio con sportello pubblicità incassata nel muro e assemblata con cornice sul fronte.

Example of Curve set composed to 10 mailboxes with double box for publicity with cover frame.



Esempio di blocchiera Modular 1V composta da 14 cassette postali incassata nel muro, assemblata con cornice sul fronte.

Example of Modular 1V set composed to 14 mailboxes with cover frame.

## BTicino Sfera

Dimensioni (cm) - Dimensions (cm).

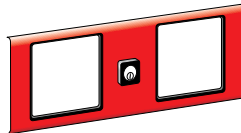
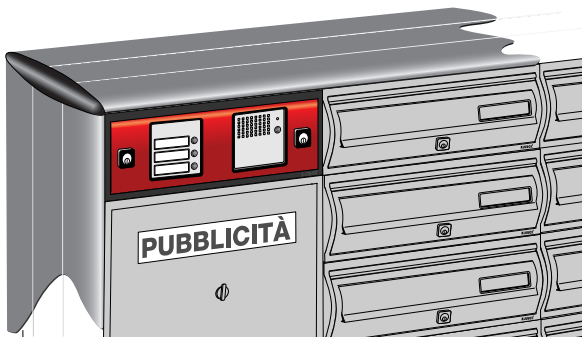

**SP ACC SF**  
Sportello porta accessori per Sfera  
Intercom panel



**332911**  
modulo cieco  
blank module



**332201**  
modulo n civico  
house number module



**332501**  
modulo telecamera  
camera module



**332101**  
modulo citofono  
intercom module



**332111**  
modulo citofono + 1 pulsante  
intercom + 1 bell push module



**332121**  
modulo citofono + 2 pulsanti  
intercom + 2 bell pushes module



**332231**  
modulo 3 pulsanti  
3 bell pushes module



**332241**  
modulo 4 pulsanti  
4 bell pushes module



Esempio con sportello porta accessori  
Example with intercom panel



Esempio Jumbo LUX1  
con sportello porta accessori  
Example Jumbo LUX1 with intercom panel

## BTicino Sfera - New Sfera - Robur

Dimensioni (cm) - Dimensions (cm).

Solo predisposizione per Serie Sfera, New Sfera e Robur.

Only predisposition for Sfera, New Sfera and Robur series.

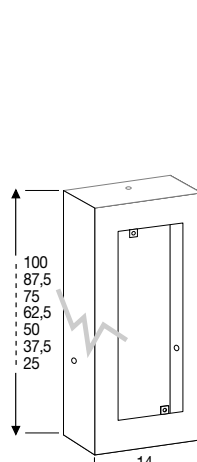
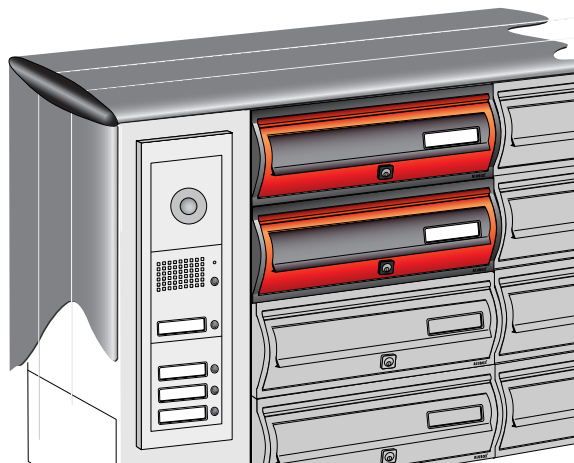

Placca porta accessori  
Intercom box

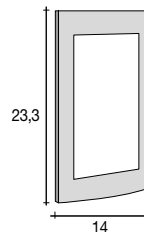

**331221**  
Telaio porta moduli SFERA da 2 moduli  
SFERA module frame for 2 modules

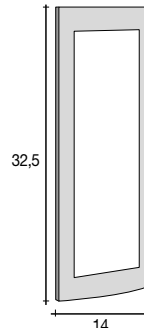

**331231**  
Telaio porta moduli SFERA da 3 moduli  
SFERA module frame for 3 modules



Esempio con sportello porta accessori e NEW SFERA  
Example with intercom panel and NEW SFERA



Esempio con placca porta accessori  
Example with camera accessories intercom panel

Placca porta accessori disponibile nei colori anodizzato argento e bronzo o verniciato rosso, verde, bianco, grigio antracite RAL 7016, ruggine e metallizzato argento.

Accessories intercom panel. Colors available: anodized silver and bronze or painted in red, green, white, anthracite color RAL 7016, rust and metallic silver.

# BTicino Minisfera

Dimensioni (cm) - Dimensions (cm).

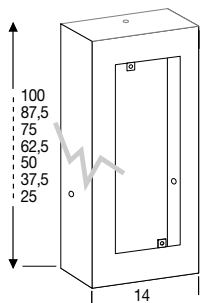
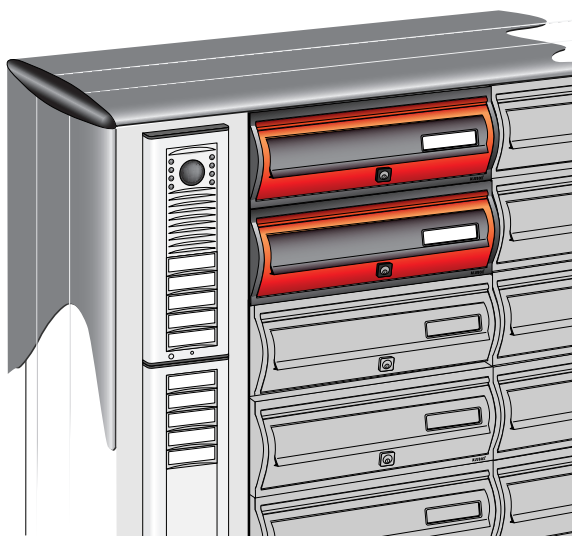

Placca porta accessori  
Intercom box

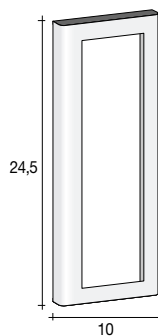

**332721**  
Telaio porta moduli MINISFERA da 10 posti  
MINISFERA module frame for 10 elements



**332715**  
pulsante cieco 1 posto  
1 space bell push blank



**332714**  
n civico 2 posti  
2 spaces house number



**332712**  
pulsante 1 posto  
1 space bell push



**332713**  
pulsante doppio 2 posti  
2 spaces bell pushes



**332702**  
citofono 4 posti  
4 spaces intercom



**332708**  
telecamera + citofono 6 posti  
6 spaces camera + intercom



Placca porta accessori disponibile nei colori anodizzato argento e bronzo o verniciato rosso, verde, bianco, grigio antracite RAL 7016, ruggine e metallizzato argento.  
Accessories intercom panel. Colors available: anodized silver and bronze or painted in red, green, white, anthracite color RAL 7016, rust and metallic silver.



# BPT Targha

Dimensioni (cm) - Dimensions (cm).

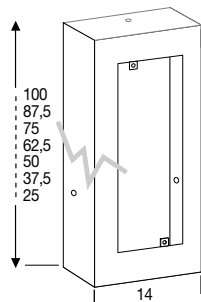
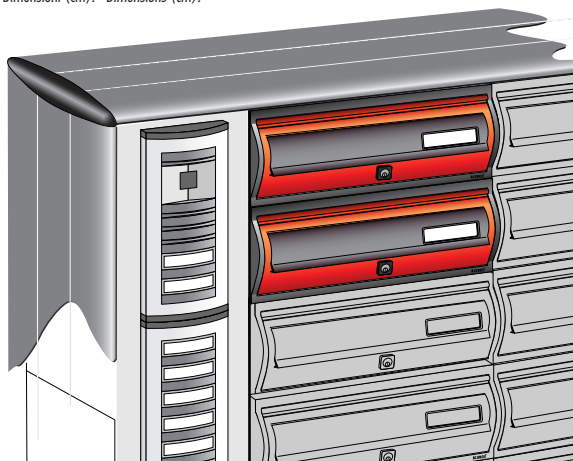

Placca porta accessori  
Intercom box

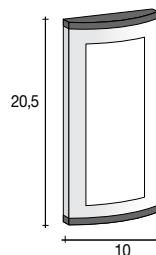

Telaio porta moduli TARGHA da 6 posti  
TARGHA module frame for 6 elements



**KHPS**  
pulsante 1 posto  
1 space bell push



**HPC/1 ST**  
citofono 2 posti  
2 spaces intercom



**15**  
**KHIN**  
n civico 2 posti  
2 spaces residence number



**HPV/1 ST**  
telecamera 2 posti  
2 spaces camera

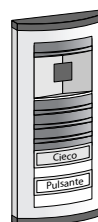

**HPV/1 ST**  
Placca Videocitofonica con 1 pulsante  
(estendibile a 2 pulsanti)  
Intercom panel for 1 or 2 bell pushes

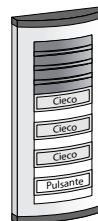

**HPC/1 ST**  
Placca citofonica con 1 pulsante  
(estendibile a 4 pulsanti)  
Intercom panel for 1, 2, 3 or 4  
bell pushes

Placca porta accessori disponibile nei colori anodizzato argento e bronzo o verniciato rosso, verde, bianco, grigio antracite RAL 7016, ruggine e metallizzato argento.  
Accessories intercom panel. Colors available: anodized silver and bronze or painted in red, green, white, anthracite color RAL 7016, rust and metallic silver.



# ELVOX Galileo

Dimensioni (cm). - Dimensions (cm).

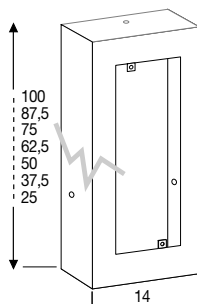
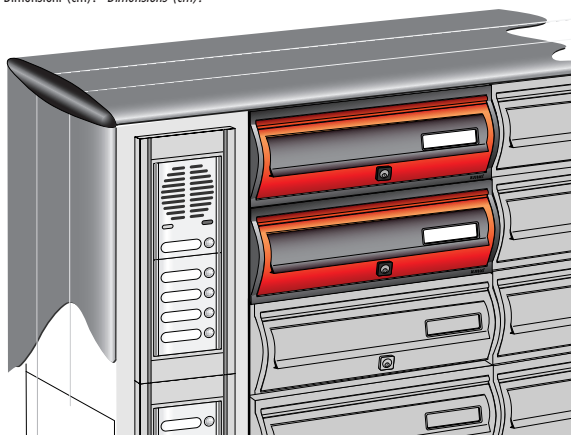

Placca porta accessori  
Intercom box

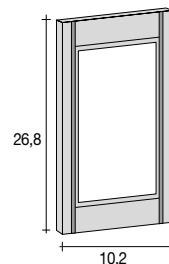

**8082**  
Telaio porta moduli GALILEO da 2 moduli  
GALILEO module frame for 2 modules.

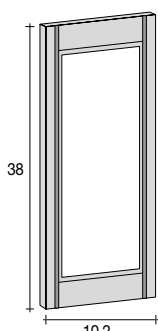

**8083**  
Telaio porta moduli GALILEO da 3 moduli  
GALILEO module frame for 3 modules.

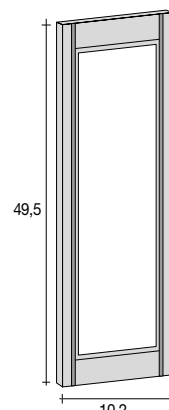

**8084**  
Telaio porta moduli GALILEO da 4 moduli  
GALILEO module frame for 4 modules.



**8000**  
modulo cieco  
blank module

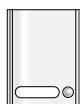

**8001**  
modulo  
1 pulsante  
1 bell push  
module



**8002**  
modulo  
2 pulsanti  
2 bell pushes  
module



**8003**  
modulo  
3 pulsanti  
3 bell pushes  
module



**8004**  
modulo  
4 pulsanti  
4 bell pushes  
module



**8010**  
modulo citofono  
intercom module



**8011**  
modulo citofono  
+ 1 pulsante  
intercom  
+ 1 bell push module



**800N**  
modulo n civico  
residence  
number module



**8019**  
modulo telecamera  
+ citofono  
camera  
+ intercom module

Placca porta accessori disponibile nei colori anodizzato argento e bronzo o verniciato rosso, verde, bianco, grigio antracite RAL 7016, ruggine e metallizzato argento.  
Accessories intercom panel. Colors available: anodized silver and bronze or painted in red, green, white, anthracite color RAL 7016, rust and metallic silver.



# Urmet Sinthesi

Dimensioni (cm) - Dimensions (cm).

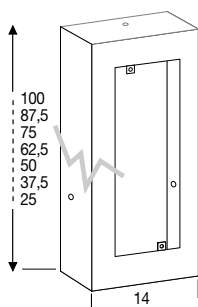
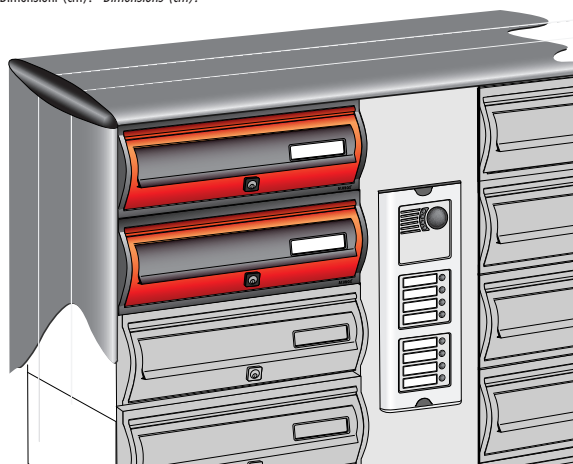

Placca porta accessori  
Intercom box

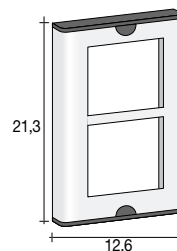

**1145/62**

Telaio porta moduli SINTHESI da 2 moduli  
SINTHESI module frame for 2 modules

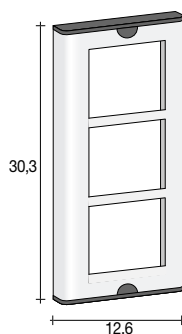

**1145/63**

Telaio porta moduli SINTHESI da 3 moduli  
SINTHESI module frame for 3 modules

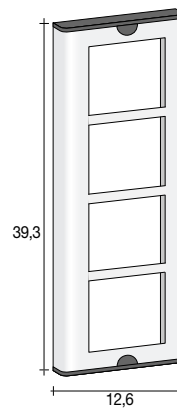

**1145/64**

Telaio porta moduli SINTHESI da 4 moduli  
SINTHESI module frame for 4 modules



**1145/20**  
modulo citofono  
intercom module



**1145/21**  
modulo citofono  
+ 1 pulsante  
intercom  
+ 1 bell push  
module



**1145/22**  
modulo citofono  
+ 2 pulsanti  
intercom  
+ 2 bell pushes  
module



**1145/11**  
modulo  
1 pulsante  
bell push  
module



**1145/12**  
modulo  
2 pulsanti  
bell pushes  
module



**1145/13**  
modulo  
3 pulsanti  
bell pushes  
module



**1145/14**  
modulo  
4 pulsanti  
bell pushes  
module



**1145/59**  
modulo cieco  
blank module



**1145/50**  
modulo n civico  
house number  
module



**1745/80**  
modulo  
videocitofono  
camera  
+ intercom module

Placca porta accessori disponibile nei colori anodizzato argento e bronzo o verniciato rosso, verde, bianco, grigio antracite RAL 7016, ruggine e metallizzato argento.  
Accessories intercom panel. Colors available: anodized silver and bronze or painted in red, green, white, anthracite color RAL 7016, rust and metallic silver.



Esempio con placca porta accessori  
Example with camera accessories panel

# Aiphone GF audio & video

Dimensioni (cm). - Dimensions (cm).

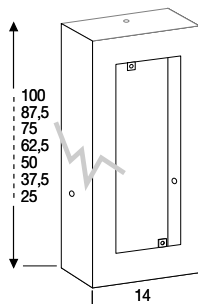
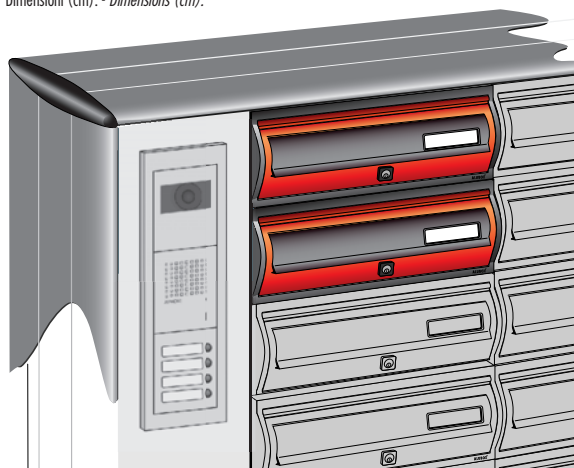

Placca porta accessori  
Intercom box

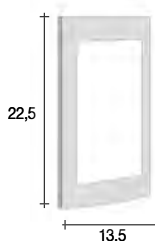

**GF 2F**  
Telaio porta moduli GF 2F da 2 moduli  
GF 2F module frame for 2 modules

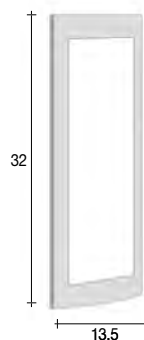

**GF 3F**  
Telaio porta moduli GF 3F da 2 moduli  
GF 3F module frame for 3 modules



**GF DP**  
modulo citofono  
intercom module



**GF 1P**  
modulo  
+ 1 pulsante  
1 bell push  
module



**GF 2P**  
modulo  
+ 2 pulsanti  
2 bell pushes  
module



**GF 3P**  
modulo  
+ 3 pulsanti  
+ elettronica  
3 bell pushes  
module  
+ control unit



**GF 4P**  
modulo  
+ 4 pulsanti  
+ elettronica  
4 bell pushes  
module  
+ control unit



**GF BP**  
modulo cieco  
blank module



**GF AP**  
modulo n civico  
house number  
module



**GF VF**  
modulo telecamera  
camera module

Placca porta accessori disponibile nei colori anodizzato argento e bronzo o verniciato rosso, verde, bianco, grigio antracite RAL 7016, ruggine e metallizzato argento.  
Accessories intercom panel. Colors available: anodized silver and bronze or painted in red, green, white, anthracite color RAL 7016, rust and metallic silver.





Serie CURVE



MODELLO CONFORME  
EN 13724



serie CURVE



MODELLO CONFORME  
EN 13724



Serie MODULAR



MODELLO CONFORME  
EN 13724



Casellari postali composti  
Composed mailbox sets



Cassette postali componibili  
*Combinable mailboxes*





Cassette postali singole  
*Single mailboxes*





ESEMPI DI INSTALLAZIONE IN ESTERNO • *EXAMPLES OF OUTDOORS INSTALLATION*

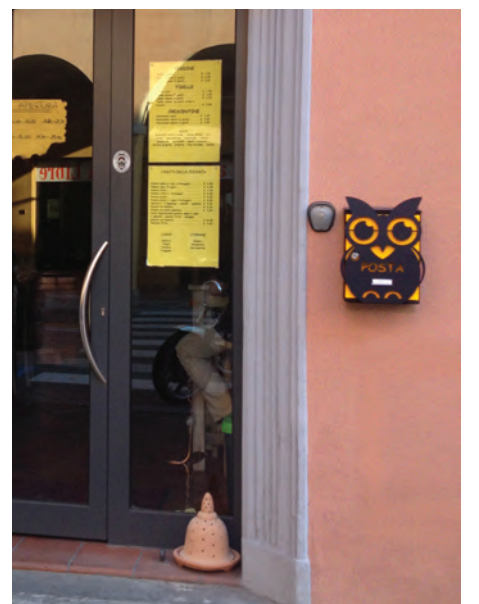
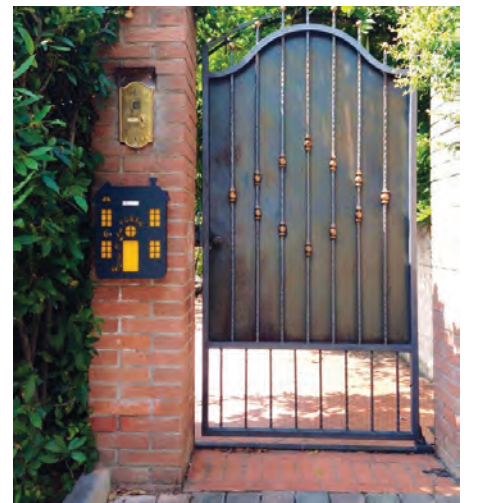

# Cassette postali per tutti i gusti



# ALUBOX

*Cassette Postali - Mailboxes*

# Cassetta Postale Personalizzabile - Custom Mailboxes



Cassetta postale da esterno formato rivista personalizzabile realizzata in lamiera zincata verniciata alle polveri disponibile con sportello giallo o azzurro.

La cover è intercambiabile e può essere sostituita semplicemente svitando i dadi autobloccanti dall'interno dello sportello.

## Come funziona - How it works

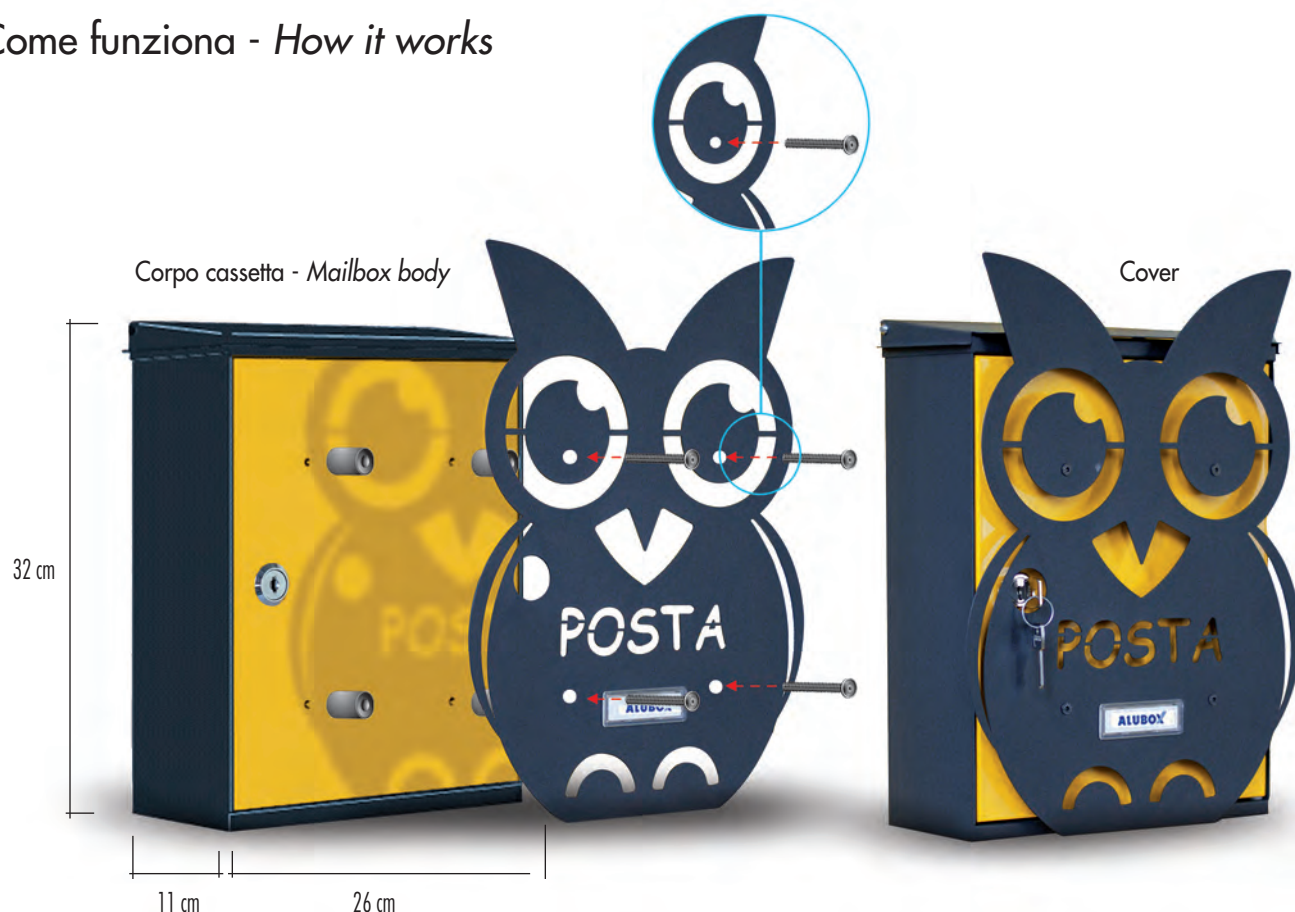

## Ambientazioni - Examples of installation



Customized mailbox for outdoors magazine format made in galvanized sheet steel epoxy powder painted.

Available with door in yellow or blue color.

The covers are interchangeable and can be easily replaced by self-blocking screws in the rear of the door.





Scegli la cover che preferisci e personalizza la tua cassetta tutte le volte che vuoi. Le cover sono realizzate in lamiera zincata verniciata alle polveri nei colori: bianco, verde, rosso, grigio antracite Ral 7016, ruggine, viola e giallo.

Confezione corpo cassetta 4 pezzi.

Confezione cover 2 pezzi.

Gufo - Owl



Ape - Bee



Leone - Lion



Bulldog - Bulldog



Gatti - Cat lovers



Micio - Cat



Geco - Gecko



Rana - Frog



Tartaruga - Turtle



Coccinella - Ladybug



Cuccia - Kemele



Farfalla - Butterfly



Margherita - Daisy



Tulipano - Tulip



Quadrifoglio - Four-leaf clover



Choose your favorite Mia covers and change it as many times as you want. Covers are in galvanized sheet steel epoxy powder painted: white, green, red, anthracite Ral 7016 finish, rust, violet and yellow.

Mailbox body 4-pieces package.  
Covers 2-pieces package



Motoretta - Motorbike



Scooter - Scooter



Casa con rampicante  
Climber home



Casa - Home



Francobollo - Stamp



Ombrellone  
Beach umbrella



Barca a vela  
Sailing boat



Pesce - Fish



Babbo Natale  
Santa Claus



Sciatore - Skier

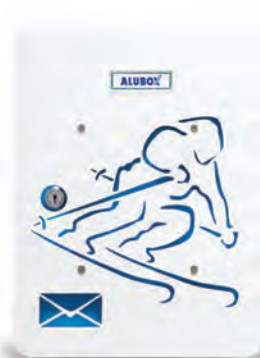

Angelo - Angel



Albero verde - Green tree



Slitta - Sled



Albero rosso - Red tree



Palo per cassetta MIA completo di piastra per fissaggio e viteria. In lamiera elettrozincata verniciata nero.  
Pole for MIA mailbox complete of plate for fixing and screws. In electrogalvanized sheet steel black painted.

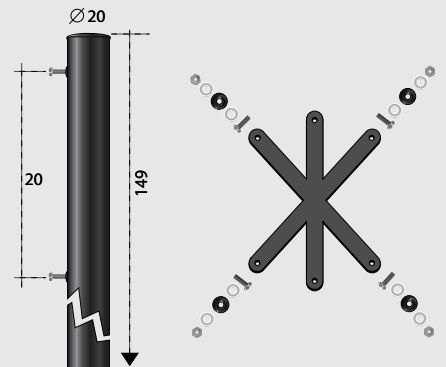

Traversini per fissaggio a cancellata in lamiera elettrozincata verniciata colore nero, completi di viti e bulloni.

Braces electrogalvanized sheet steel black painted for fixing MIA mailboxes to fencing complete of screws.

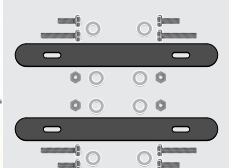



# Portachiavi da Interno - *Key-Stand for Indoors*



MADE IN ITALY

Miakey è il portachiavi da parete di design per interni con 16 ganci.

*Miakey is a keyboards for indoors with 16 hooks.*

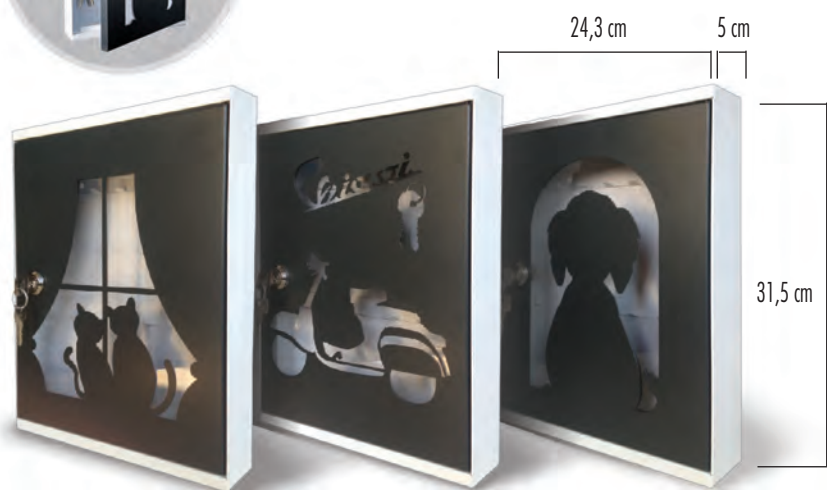

GATTI - Cat Lovers

MOTORETTA - Motorbike

CUCCIA - Kennel

Corpo e sportelli in lamiera zincata verniciati alle polveri rispettivamente nei colori bianco e grigio antracite Ral 7016. Sportello con intagli laser e plexiglass trasparente.

\* Realizzati in lamiera zincata verniciata alle polveri di colore bianco con sportello serigrafato in quadricromia.

Confezione 2 pezzi

*Body and doors in galvanized sheet steel epoxy powder painted in white and anthracite Ral 7016 colors respectively. Door with laser carvings and transparent plexiglass.*

*\* Manufactured in electrogalvanized sheet steel with silk-screen printing door.*

*2-pieces package*



\*LIFE - Life

\*GUFU - Owls

\*GARAGE - Garage

\*GATTO - Cat

\*CUORE - Heart



Ambientazioni - *Examples of installation*

# Porta Spirali Antizanzara - *Spiral Holder Anti-Mosquitos*



Porta spirali antizanzara realizzati in lamiera zincata spessore mm 0,7 con intagli laser verniciato alle polveri in diversi colori.

*Spiral Holders anti-mosquitos in galvanized sheet steel thickness mm 0.7 with laser carvings epoxy powder painted in different colors.*

## ZampirINO

Confezione 10 pezzi per soggetto  
10-PIECES package for item

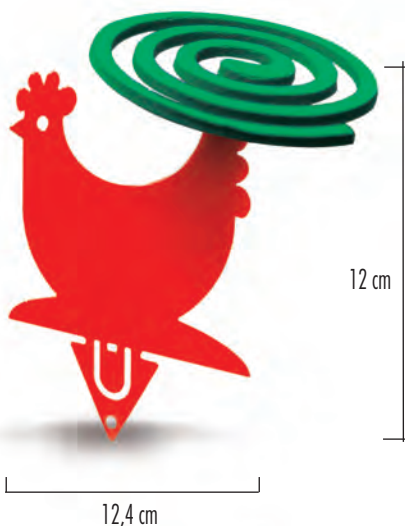

## ZampirELLA

Confezione 10 pezzi per soggetto  
10-PIECES package for item

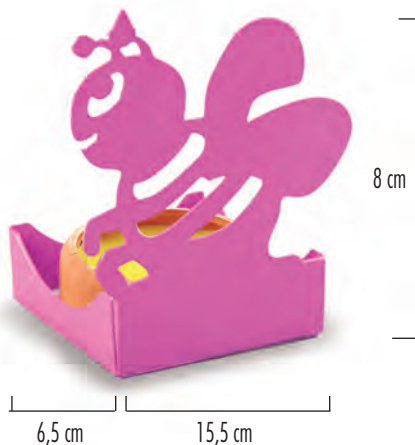

## ZampirONE

Confezione 8 pezzi per soggetto  
8-PIECES package for item



# Porta Spirali Antizanzara - *Spiral Holder Anti-Mosquitos*



MADE IN ITALY

## ZampirINO

PORTA SPIRALE ANTIZANZARA



GALLINA - Hen



RANA - Frog



ZANZARA - Mosquito



GUFO - Owl

## ZampirELLA

PORTA CITRONELLA O CANDELA

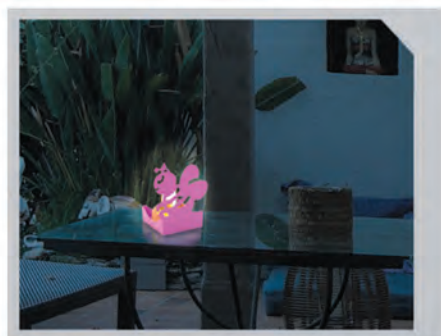

APE - Bee



CANE - Dog



RANA - Frog

## ZampirONE

PORTA SPIRALE ANTIZANZARA



FARFALLA - Butterfly



SCOOTER - Scooter



GATTI - Cat Lovers



CANE - Dog



APE - Bee



TARTARUGA - Turtle



GECO - Gecko



GATTI - Cat Lovers



FARFALLA - Butterfly



GECO - Gecko



MARGHERITA - Daisy



FARFALLA - Butterfly



GUFO - Owl



GATTI - Cat Lovers

# Cassette Postali SINGOLE

MADE IN ITALY

## Serie XE

Esterno



XEBR

(confezione da 8 pezzi)

### PER ESTERNO

- XEBR** • In alluminio anodizzato bronzo
- XEAR** • In alluminio anodizzato argento
- XEGH** • In alluminio verniciato grigio antracite Ral 7016

(8-pieces package)

### OUTDOORS

- XEBR** • Aluminium - bronze anodized
- XEAR** • Aluminium - silver anodized
- XEGH** • Aluminium - Ral 7016 anthracite finish



XEGH



XEAR

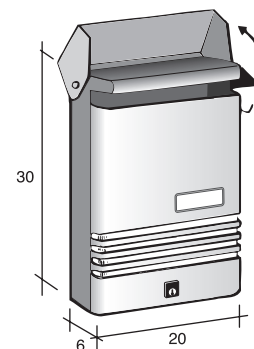

MADE IN ITALY

## Serie XER

Esterno formato RIVISTA



XERBR

(confezione da 5 pezzi)

### PER ESTERNO

- XERBR** • In alluminio anodizzato bronzo
- XERAR** • In alluminio anodizzato argento
- XERGH** • In alluminio verniciato grigio antracite Ral 7016

(5-pieces package)

### OUTDOORS - MAGAZINE FORMAT

- XERBR** • Aluminium - bronze anodized
- XERAR** • Aluminium - silver anodized
- XERGH** • Aluminium - Ral 7016 anthracite finish



XERGH



XERAR

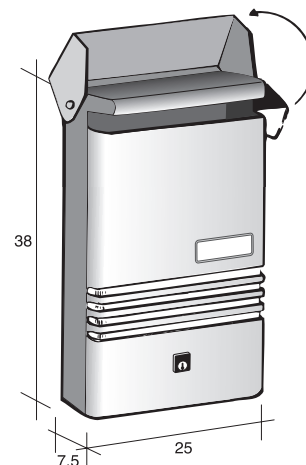

# Serie UNO



UTMAXIRO

(confezione da 6 pezzi)

**PER ESTERNO - FORMATO RIVISTA**

- UTMAXIAV** • In lamiera verniciata colore avorio
- UTMAXIVE** • In lamiera verniciata colore verde
- UTMAXIRO** • In lamiera verniciata colore rosso
- UTMAXIGH** • In lamiera verniciata colore grigio antracite Ral 7016

(6-pieces package)

**OUTDOORS - MAGAZINE FORMAT**

- UTMAXIAV** • Sheet steel - ivory paint finish
- UTMAXIVE** • Sheet steel - green paint finish
- UTMAXIRO** • Sheet steel - red paint finish
- UTMAXIGH** • Sheet steel Ral 7016 anthracite finish



UTMAXIGH



UTMAXIAV



UTMAXIVE

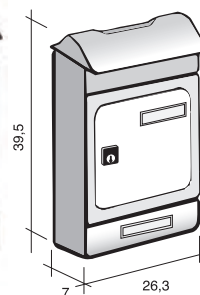

# Serie TOPOLINO



USA1RO

(confezione da 1 pezzo)

**PER ESTERNO - FORMATO RIVISTA**

- USA1** • Cassetta Topolino in lamiera zincata verniciata nei colori: bianco, nero, rosso, verde e argento.

**Accessorio da ordinare separatamente:**

- USAPL** • Palo per serie Topolino in lamiera zincata verniciato nero.

(1-piece package)

**OUTDOORS - MAGAZINE FORMAT**

- USA1** • Topolino mailbox in galvanized sheet steel painted. Colors available: white, black, red, green, silver.

**Accessory to order separately:**

- USAPL** • Post for Topolino series galvanized sheet steel painted in black color.

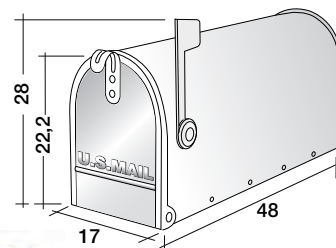

USA1AR



USA1VE



USA1BI



USA1NE

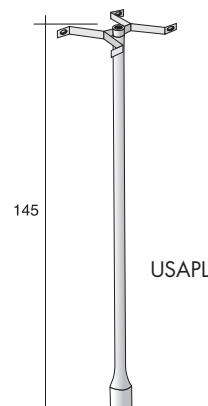

# Serie EFFE



FTIX



(confezione da 8 pezzi)

**PER ESTERNO**

**MODELLO CON TETTO APRIBILE**

- FTIX** • In acciaio inox AISI 304 finitura TDL (Tela Di Lino)
- FTVGH** • In lamiera elettrozincata verniciata grigio antracite Ral 7016
- FTVRO** • In lamiera elettrozincata verniciato rosso
- FTVVE** • In lamiera elettrozincata verniciato verde

**MODELLO CON TETTO FISSO**

- F1IX** • In acciaio inox AISI 304 finitura TDL (Tela Di Lino)

(8-pieces package)

**OUTDOORS**

**WITH WEATHER HOOD CAN BE OPENED**

- FTIX** • AISI 304 - TDL finish
- FTVGH** • Electrogalvanized sheet steel Ral 7016 anthracite finish
- FTVRO** • Electrogalvanized sheet steel red paint finish
- FTVVE** • Electrogalvanized sheet steel green paint finish

**FIXED WEATHER HOOD**

- F1IX** • AISI 304 stainless steel - TDL finish

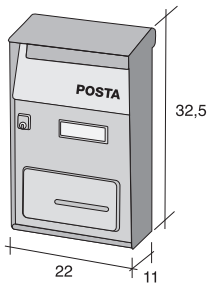

FT Modello con tetto  
FT With weather hood



F1IX

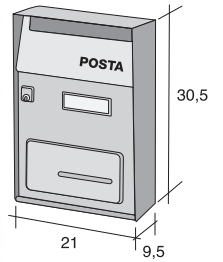

F1 - Modello senza tetto  
F1 - Without weather hood

MADE IN CHINA



FTVRO



FTVVE



FTVGH

MADE IN CHINA

# Serie EFFE T EVO



FTIXL

(confezione da 8 pezzi)

**PER ESTERNO**

**MODELLO CON TETTO APRIBILE**

- FTIXL** • In acciaio inox AISI 304 liscio

(8-pieces package)

**OUTDOORS**

**WITH WEATHER HOOD CAN BE OPENED**

- FTIXL** • AISI 304 stainless steel

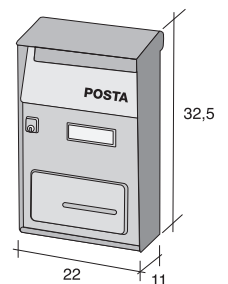



DR2EIX



(confezione da 6 pezzi)

**PER ESTERNO - FORMATO RIVISTA  
MODELLO CON TETTO****DR2EIX** • In acciaio inox AISI 304  
finitura TDL (Tela Di Lino)

(6-pieces package)

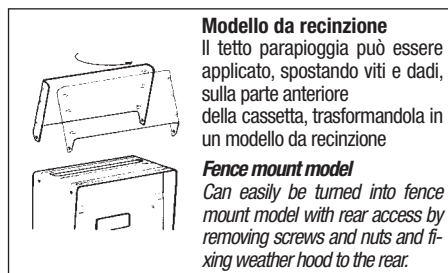
**OUTDOORS - MAGAZINE FORMAT  
WITH WEATHER HOOD****DR2EIX** • AISI 304 - TDL finish**Modello da recinzione**

Il tetto parapiovia può essere applicato, spostando viti e dadi, sulla parte anteriore della cassetta, trasformandola in un modello da recinzione

**Fence mount model**

Can easily be turned into fence mount model with rear access by removing screws and nuts and fixing weather hood to the rear.

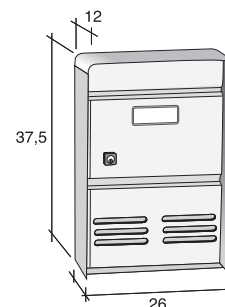

DR2EIXL

(confezione da 6 pezzi)

**PER ESTERNO - FORMATO RIVISTA  
MODELLO CON TETTO****DR2EIXL** • In acciaio inox 470LI - 24Cr

(6-pieces package)

**OUTDOORS - MAGAZINE FORMAT  
WITH WEATHER HOOD****DR2EIXL** • 470LI - 24 Cr stainless steel

Il 470LI - 24Cr è un acciaio superferritico nato dall'esigenza di proporre alternative vantaggiose ad acciai aventi elevati tenori di resistenza alla corrosione. La particolare composizione chimica (Cromo, Titanio e Niobio) e le prestazioni ottenibili fanno di questo acciaio un'evoluzione dell'AISI 304.

**Queste le caratteristiche principali rispetto al normale acciaio AISI 304: maggiore resistenza alla corrosione ed alla tenso-corrosione; maggiore robustezza del materiale; totale assenza di Nichel.**

470LI - 24Cr stainless steel is a super-ferritic grade born from the need for the availability of competitive alternatives to steel grades with high performance of corrosion resistance; the specific production process and chemical composition ensure the achieving of corrosion resistance levels higher to traditional steel grades such as AISI 304.

**470LI main features comparing to AISI 304: higher corrosion and tenso-corrosion resistance; higher material hardness; without Nichel.**

TIPO ACCIAIO STEEL GRADE	PREN		
	Min	Max	Med
AISI 304	18.8	21.3	20.1
470LI	23.8	25.3	24.5

Acciaio Stainless steel	Valore Value	Rottura Tensile strength Rm (Mpa, N/mm <sup>2</sup> )	Snervamento Yield Strength Rp <sub>0.2s</sub> (Mpa, N/mm <sup>2</sup> )	Allungamento Elongation [%]	Durezza Hardness (HRB)
470LI	Indicativo Indicative	490	330	28	72
304	Indicativo Indicative	650	300	55	80

L'indice di resistenza alla corrosione è basato sulla valutazione di un indice numerico PREN (Pitting Resistance Equivalent Number).

The ability resistance pitting by stainless steel grades is expressed through a numeric index called PREN (Pitting Resistance Equivalent Number)

L'acciaio inox utilizzato contiene circa il 65% di materiale riciclato.

The stainless steel used contains approximately a 65% of scrap as recycled material.



DUBLO EVO inox 470LI difende la natura e l'ecosostenibilità.

DUBLO EVO inox 470LI is eco-friendly.

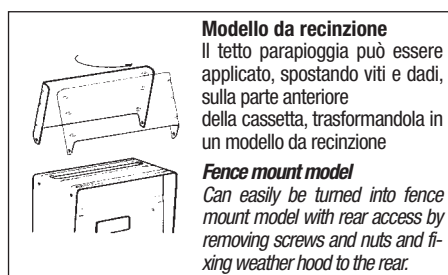
**Modello da recinzione**

Il tetto parapiovia può essere applicato, spostando viti e dadi, sulla parte anteriore della cassetta, trasformandola in un modello da recinzione

**Fence mount model**

Can easily be turned into fence mount model with rear access by removing screws and nuts and fixing weather hood to the rear.

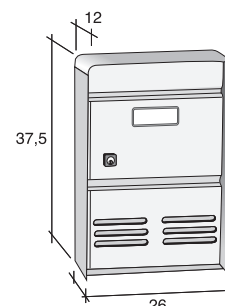



Serie **PRIMA**

PRIMANE

(confezione da 10 pezzi)

**PER ESTERNO**

- PRIMANE** • In lamiera zincata verniciata nero
- PRIMAAR** • In lamiera zincata verniciata argento
- PRIMAVE** • In lamiera zincata verniciata verde



PRIMAAR



PRIMAVE



(10-pieces package)

**OUTDOORS**

- PRIMANE** • Galvanized sheet steel black painted
- PRIMAAR** • Galvanized sheet steel silver painted
- PRIMAVE** • Galvanized sheet steel green painted

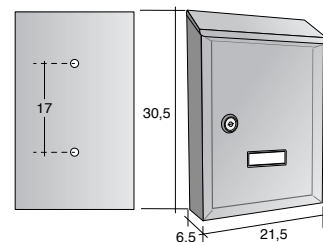
Serie **PRIMA MAXI**

PRIMAMAXIGH

(confezione da 6 pezzi)

**PER ESTERNO - FORMATO RIVISTA**

- PRIMAMAXIGH** • In lamiera zincata verniciata grigio antracite Ral 7016
- PRIMAMAXIAR** • In lamiera zincata verniciata argento
- PRIMAMAXIVE** • In lamiera zincata verniciata verde



PRIMAMAXIAR



PRIMAMAXIVE



(6-pieces package)

**OUTDOORS - MAGAZINE FORMAT**

- PRIMAMAXIGH** • Galvanized sheet steel Ral 7016 anthracite finish
- PRIMAMAXIAR** • Galvanized sheet steel silver painted
- PRIMAMAXIVE** • Galvanized sheet steel green painted

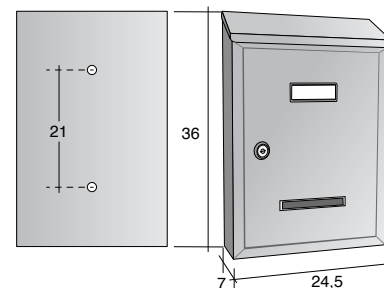
Serie **REGIE POSTE**

REGIEGH

(confezione da 4 pezzi)

**PER ESTERNO - FORMATO RIVISTA**

- REGIEGH** • Frontale in alluminio pressofuso e corpo in lamiera zincata verniciati alle polveri color grigio antracite Ral 7016
- REGIEBR** • Frontale in alluminio pressofuso e corpo in lamiera zincata verniciati alle polveri color bronzo
- REGIEVE** • Frontale in alluminio pressofuso e corpo in lamiera zincata verniciati alle polveri color verde
- REGIERO** • Frontale in alluminio pressofuso e corpo in lamiera zincata verniciati alle polveri color rosso

(4-pieces package)

**OUTDOORS - MAGAZINE FORMAT**

- REGIEGH** • Front in die-cast aluminium and body in galvanized sheet steel, epoxy powder painted. Ral 7016 anthracite finish
- REGIEBR** • Front in die-cast aluminium and body in galvanized sheet steel, epoxy powder painted. Bronze color
- REGIEVE** • Front in die-cast aluminium and body in galvanized sheet steel, epoxy powder painted. Green color
- REGIERO** • Front in die-cast aluminium and body in galvanized sheet steel, epoxy powder painted. Red color



REGIEBR



REGIEVE



REGIERO

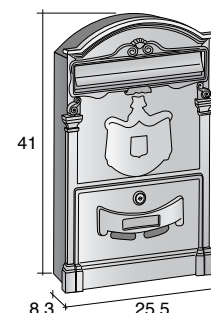

# Serie QUADRA



QUADRAIX

(confezione da 6 pezzi)

**PER ESTERNO - FORMATO RIVISTA**

- QUADRAIX** • In acciaio inox
- QUADRAMIX** • Corpo in lamiera zincata verniciata grigio antracite Ral 7016 / sportello ed elemento mobile in acciaio inox
- QUADRABI** • In lamiera zincata verniciata bianco
- QUADRAGH** • In lamiera zincata verniciata grigio antracite Ral 7016

(6-pieces package)

**OUTDOORS - MAGAZINE FORMAT**

- QUADRAIX** • AISI 304 stainless steel
- QUADRAMIX** • Galvanized sheet steel body Ral 7016 anthracite finish / door and flap in stainless steel
- QUADRABI** • Galvanized sheet steel white painted
- QUADRAGH** • Galvanized sheet steel Ral 7016 anthracite finish

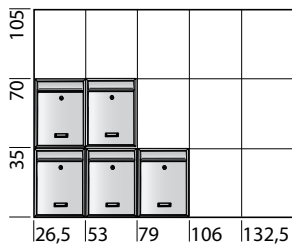

Cassetta postale adatta per soluzioni componibili.

Units assembled and banked as required.



QUADRAMIX



QUADRAGH



QUADRABI

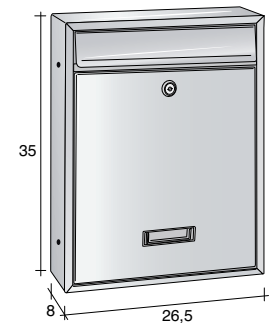

# Serie IBIZA



IBIZAGH

(confezione da 4 pezzi)

**PER ESTERNO - FORMATO RIVISTA**

- IBIZA** • In alluminio pressofuso verniciato disponibile nei colori: grigio antracite Ral 7016, verde e bianco.

(4-piece package)

**OUTDOORS - MAGAZINE FORMAT**

- IBIZA** • Die-cast aluminium painted in the following colors: Ral 7016 anthracite finish, green and white.



IBIZAVE



IBIZABI

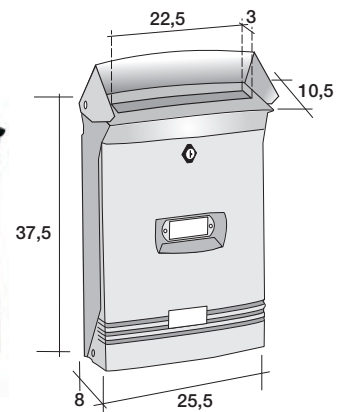

Serie **BUSTA**

BUSTAAR

**Sistema anti-effrazione**  
**Comoda apertura a vasistas**  
**Resistente all'acqua**  
**Garantita anticorrosione**

(confezione da 2 pezzi)

**PER ESTERNO - FORMATO RIVISTA**

Cassetta postale per esterni di grandi dimensioni in lamiera elettrozincata verniciata alle polveri. Dal design moderno, con l'introduzione dall'alto e il prelievo frontale, da parete o cancellata.

Disponibile nei colori:

- **BUSTAAR** metallizzato argento
- **BUSTAVE** verde
- **BUSTARO** rosso
- **BUSTAGH** grigio antracite Ral 7016

**Antivandal system**  
**Comfortable opening**  
**Water resistant**  
**Warranty corrosionproof**

(2-pieces package)

**OUTDOORS - MAGAZINE FORMAT**

Large mailbox for outdoors, magazine format in electrogalvanized sheet steel epoxy powder painted with top drop, front access, designed for wall or fence installations colors available:

- **BUSTAAR** silver
- **BUSTAVE** green
- **BUSTARO** red
- **BUSTAGH** Ral 7016 anthracite finish



BUSTARO



BUSTAVE

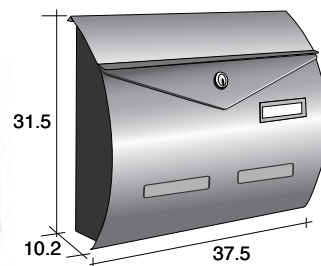

BUSTAGH

Serie **LETTERE**

LETTERERO

**Comoda apertura a vasistas**  
**Resistente all'acqua**  
**Alluminio pressofuso**  
**Serratura in ottone**  
**Garantita anticorrosione**

(confezione da 2 pezzi)

**PER ESTERNO - FORMATO RIVISTA**

Pratica ed elegante cassetta postale per esterno in alluminio pressofuso verniciata per formato rivista. Con l'introduzione dall'alto e il prelievo frontale, da parete o cancellata.

Disponibile nei colori:

- **LETTERERO** - rosso
- **LETTEREVE** - verde
- **LETTERERU** - ruggine
- **LETTEREGH** - grigio antracite Ral 7016

**Comfortable opening**  
**Water resistant**  
**Die-cast aluminium**  
**Brass lock**  
**Warranty corrosionproof**

(2-pieces package)

**OUTDOORS - MAGAZINE FORMAT**

Large mailbox for outdoors installations in die cast aluminium painted with top drop, front access, designed for wall or fence installations. Colors available:

- **LETTERERO** - red
- **LETTEREVE** - green
- **LETTERERU** - rust
- **LETTEREGH** - Ral 7016 anthracite finish



LETTEREGH



LETTEREVE



LETTERERUG

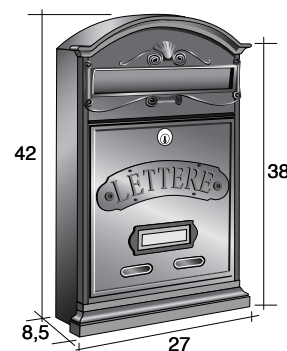

# Serie RESIDENCE



RESRUG

Con trattamento anticorrosione

(confezione da 2 pezzi)  
**PER ESTERNO - FORMATO RIVISTA RES**  
 In alluminio pressofuso anodizzato e verniciato colore rosso, nero, verde, grigio antracite Ral 7016 e ruggine.

Corrosionproof treatment

(2-pieces package)  
**OUTDOORS - MAGAZINE FORMAT RES**  
 In die-cast anodized aluminium painted in the following colors: red, black, green, Ral 7016 anthracite finish and rust.



RESRO



RESVE



RESGH



RESNE

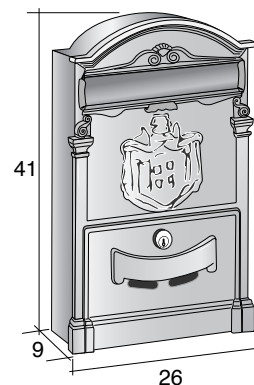

# Serie RESIDENCE MAXI



RESMAXIGH

Con trattamento anticorrosione

(confezione da 2 pezzi)  
**PER ESTERNO - FORMATO RIVISTA RESMAXI**  
 In alluminio pressofuso verniciato colore rosso, nero, verde, grigio antracite Ral 7016 e ruggine.

Corrosionproof treatment

(2-pieces package)  
**OUTDOORS - MAGAZINE FORMAT RESMAXI**  
 Die-cast aluminium painted in the following colors: red, black, green, Ral 7016 anthracite finish and rust.



RESMAXIRO



RESMAXIVE



RESMAXIRUG



RESMAXINE

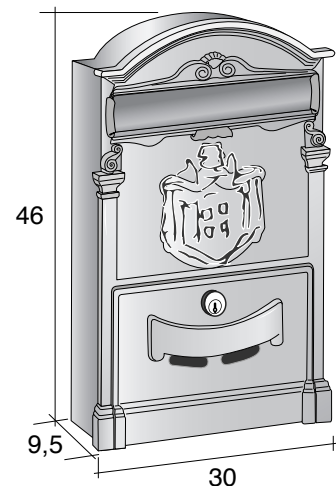

# Serie VILLA



VILLAIX

(confezione da 6 pezzi)  
**PER ESTERNO - FORMATO RIVISTA**  
**VILLAIX** • In acciaio inox AISI 304  
**VILLAGH** • In lamiera zincata verniciata grigio antracite Ral 7016.



VILLAGH



(6-pieces package)  
**OUTDOORS - MAGAZINE FORMAT**  
**VILLAIX** • Stainless steel  
**VILLAGH** • Galvanized sheet steel Ral 7016 anthracite finish

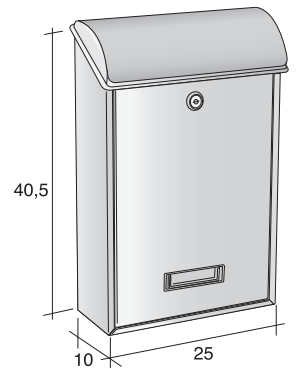

# Serie CHALET



CHALETGH

(confezione da 5 pezzi)  
**PER ESTERNO - FORMATO RIVISTA**  
**CHALETGH** • In lamiera zincata verniciata grigio antracite Ral 7016.  
**CHALETBI** • In lamiera zincata verniciata bianco



CHALETBI



(5-pieces package)  
**OUTDOORS - MAGAZINE FORMAT**  
**CHALETGH** • Galvanized sheet steel Ral 7016 anthracite finish  
**CHALETBI** • Galvanized sheet steel white painted

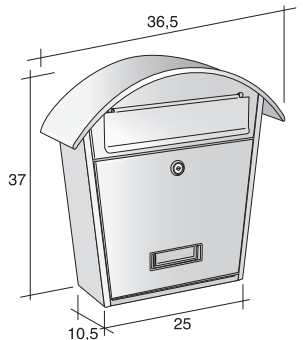

# Serie PECHINO



PECHINO

(confezione da 5 pezzi)  
**PER ESTERNO - FORMATO RIVISTA**  
**PECHINOIX** • In acciaio inox AISI 304  
**PECHINO** • In lamiera zincata verniciata grigio antracite Ral 7016.  
**PECHINOAR** • In lamiera zincata verniciata argento



PECHINO



PECHINOAR



(5-pieces package)  
**OUTDOORS - MAGAZINE FORMAT**  
**PECHINOIX** • Aisi 304 stainless steel  
**PECHINO** • Galvanized sheet steel Ral 7016 anthracite finish  
**PECHINOAR** • Galvanized sheet steel silver painted

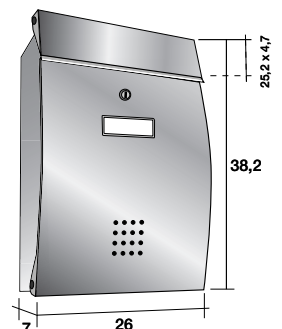

# Serie EUROPA MAXI



EUMAXIARMET

## Con trattamento anticorrosione

(confezione da 2 pezzi)

### PER ESTERNO - FORMATO RIVISTA EUMAXI

- In alluminio pressofuso verniciato nei colori rosso, verde, nero opaco, grigio antracite Ral 7016, metallizzato argento, ruggine e bianco.

## Corrosionproof treatment

(2-pieces package)

### OUTDOORS - MAGAZINE FORMAT EUMAXI

- Die - cast aluminium painted. Colors available: red, green, matt black, Ral 7016 anthracite finish, metallic silver, rust and white.

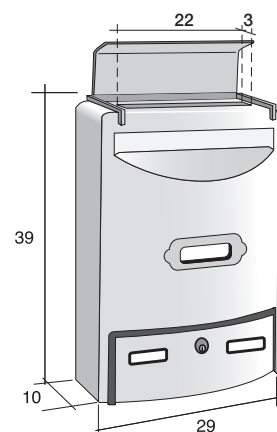

EUMAXIRUG



EUMAXIRO



EUMAXIBI



EUMAXIGH



EUMAXIVE



EUMAXINE

# Serie SATURNO

(confezione da 2 pezzi)

### PER ESTERNO - FORMATO RIVISTA SATURNO

- Cassetta postale per esterni di grandi dimensioni in lamiera elettrozincata verniciata alle polveri. Con un design moderno, ha l'introduzione dall'alto e il prelievo frontale, da parete o cancellata. Disponibile nei colori grigio antracite Ral 7016, metallizzato argento e bianco.

(2-pieces package)

### OUTDOORS - MAGAZINE FORMAT SATURNO

- Large mailbox for outdoors in electrogalvanized epoxy powder painted sheet steel. Modern design, top drop, front access, designed for wall or fence installation. Colors available: Ral 7016 anthracite finish, metallic silver and white.



SATURNOAR



SATURNOGH



SATURNOBI

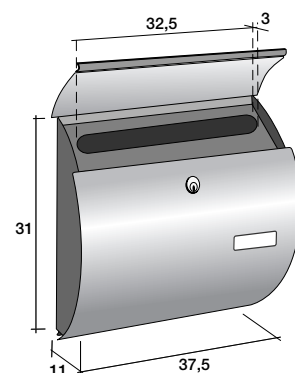

# Serie RUSTICA



**Non trattata con vernice protettiva anti-ruggine**  
**Tetto fisso**

**PER ESTERNO**

- RE** • In ferro battuto lavorato a mano verniciato nero brunito. (confezione da 6 pezzi)
- REECO** • In ferro battuto lavorato a mano verniciato nero brunito. (confezione da 12 pezzi)



**Without rust-proof paint**  
**Fixed roof**

**OUTDOORS**

- RE** • Hand-wrought iron burnished black paint finish. (6-pieces package)
- REECO** • Hand-wrought iron burnished black paint finish. (12-pieces package)

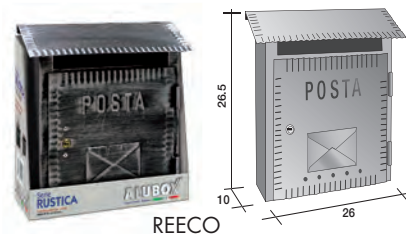

# Serie RUSTICA RIVISTA



**Non trattata con vernice protettiva anti-ruggine**

**PER ESTERNO - FORMATO RIVISTA**

- RER** • In ferro battuto lavorato a mano verniciato nero brunito. (confezione da 4 pezzi)
- RERECO** • In ferro battuto lavorato a mano verniciato nero brunito. (confezione da 6 pezzi)

**Without rust-proof paint**

**OUTDOORS - MAGAZINE FORMAT**

- RER** • Hand-wrought iron burnished black paint finish. (4-pieces package)
- RERECO** • Hand-wrought iron burnished black paint finish. (6-pieces package)

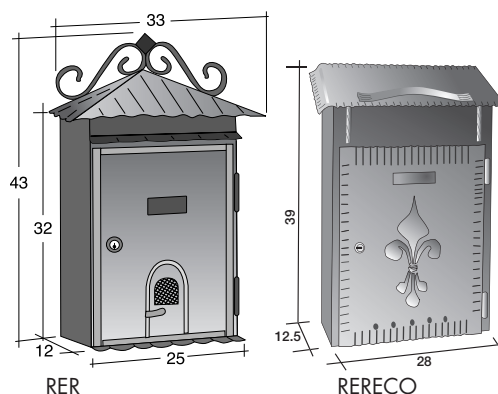

# Serie RUSTICA PORTAPANE



**Non trattata con vernice protettiva anti-ruggine**

**PER ESTERNO - FORMATO RIVISTA**

- (confezione da 2 pezzi)
- REPP** • In ferro battuto lavorato a mano verniciato nero brunito con vano portapane.

**Without rust-proof paint**

**OUTDOORS - MAGAZINE FORMAT**

- (2-pieces package)
- REPP** • Hand-wrought iron burnished black paint finish with bread box.

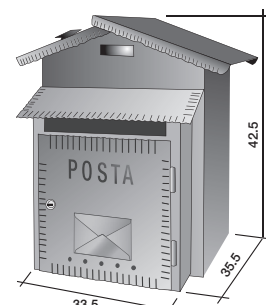
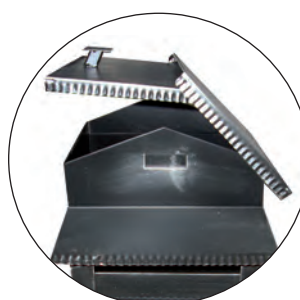

# Serie VENERE



VENEREIX

(confezione da 1 pezzo)

**PER ESTERNO - FORMATO RIVISTA**

**VENERE** • Casseta postale per esterni di grandi dimensioni con feritoia frontale e prelievo posteriore, da incasso o da cancellata passante. Disponibile in Acciaio Inox AISI 304 finitura TDL (Tela Di Lino) o in lamiera elettrozincata verniciata alle polveri in colore grigio antracite Ral 7016. Disponibile con cornice da incasso o mantello: pag 40-41.

(1-piece package)

**OUTDOORS - MAGAZINE FORMAT**

**VENERE** • Large through mounting mailbox for outdoors, with front drop and rear access, for recess or fence installation. Available in AISI 304 stainless steel, TDL finish or in electro-galvanized epoxy powder painted steel. Color: Ral 7016 anthracite finish. Available with frame for recess mounting or outer casing: see page 40-41.

Fronte / Front



Retro / Rear



VENEREGH

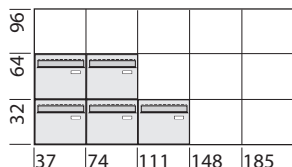
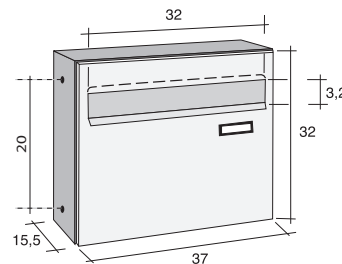

Cassetta postale adatta per soluzioni componibili. Units assembled and banked as required.

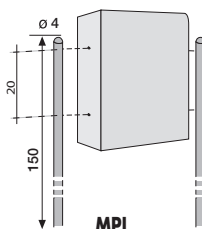

MPL

**MPL**

(confezione da 1 coppia)

Pali elettrozincati e verniciati alle polveri di colore nero per esterno.

**MPL**

((1-pair package)

Electrogalvanized stands for outdoors. Black epoxy powder painted.

# Serie GIOVE



GIOVEIX

(confezione da 1 pezzo)

**PER ESTERNO - FORMATO RIVISTA**

**GIOVE** • Casseta postale per esterni di grandi dimensioni con feritoia e prelievo frontale, da parete o cancellata. Disponibile in Acciaio Inox AISI 304 finitura TDL (Tela Di Lino) o in lamiera elettrozincata verniciata alle polveri in colore grigio antracite Ral 7016. Disponibile con cornice da incasso o mantello: pag 40-41.

(1-piece package)

**OUTDOORS - MAGAZINE FORMAT**

**GIOVE** • Large mailbox for outdoors, with front drop and front access, for wall or fence installation. Available in AISI 304 stainless steel, TDL finish or in electro-galvanized epoxy powder painted steel. Color: Ral 7016 anthracite finish. Available with frame for recess mounting or outer casing: see page 40-41.



GIOVEGH

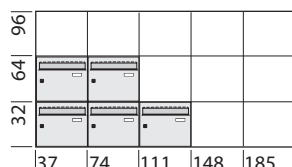
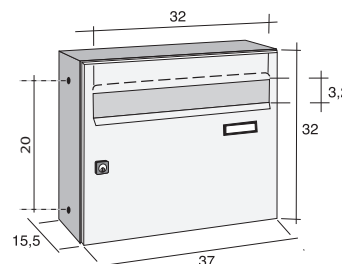

Cassetta postale adatta per soluzioni componibili. Units assembled and banked as required.

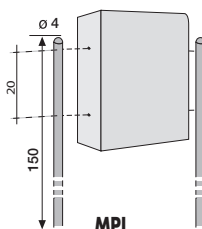

MPL

**MPL**

(confezione da 1 coppia)

Pali elettrozincati e verniciati alle polveri di colore nero per esterno.

**MPL**

((1-pair package)

Electrogalvanized stands for outdoors. Black epoxy powder painted.



# Serie MARTE



MARTEIX

(confezione da 1 pezzo)

**PER ESTERNO - FORMATO RIVISTA**

**MARTE** • Cassetta postale per esterni di grandi dimensioni dotata di tetto parapigioggia con introduzione dall'alto e prelievo frontale, da parete o cancellata. Disponibile in Acciaio Inox AISI 304 finitura TDL o in lamiera elettrozincata verniciata alle polveri in colore grigio antracite Ral 7016.

(1-piece package)

**OUTDOORS - MAGAZINE FORMAT**

**MARTE** • Large mailbox for outdoors, with weather hood, top drop and front access, designed for wall or fence installation. Available in AISI 304 stainless steel, TDL finish or in electro-galvanized epoxy powder painted steel. Color: Ral 7016 anthracite finish



MARTEGH

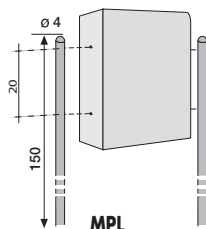
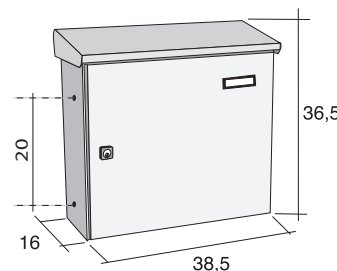

**MPL**

(confezione da 1 coppia)

Pali elettrozincati e verniciati alle polveri di colore nero per esterno.

**MPL**

((1-pair package)

Electrogalvanized stands for outdoors. Black epoxy powder painted.

# Serie SIRIO



SIRIOGH

(confezione da 4 pezzi)

**PER ESTERNO - FORMATO RIVISTA**

**SIRIO**

• Cassetta postale per esterni in lamiera elettrozincata verniciata alle polveri. Adatta per installazioni a muro o cancellata con pratica apertura dall'alto. Disponibile nei colori grigio antracite Ral 7016, avorio, verde e argento.

**SIRIO LOCK**

• Cassetta postale per esterni in lamiera elettrozincata verniciata alle polveri colore grigio antracite. Adatta per installazioni a muro o cancellata con pratica apertura dall'alto. La cassetta è provvista di serratura a combinazione a 3 numeri.

(4-pieces package)

**OUTDOORS - MAGAZINE FORMAT**

**SIRIO**

• Solid and practical mailbox for outdoors with top drop and front access. Designed for wall or fence installation. Available in electrogalvanized epoxy powder painted steel colors: Ral 7016 anthracite finish, ivory, green and silver.

**SIRIO LOCK**

• Solid and practical mailbox for outdoors with top drop and front access. Designed for wall or fence installation. Electro-galvanized epoxy powder painted steel. Color: Ral 7016 anthracite finish. Mailbox is equipped with 3 numbers lock combination.



SIRIOLOCK



SIRIOAV



SIRIOVE



SIRIOAR

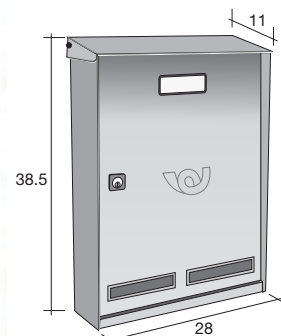

# Serie SOLE



SOLEGH

(confezione da 1 pezzo)  
**PER ESTERNO - FORMATO RIVISTA**  
 Cassetta in pressofusione d'alluminio verniciata in colore grigio antracite Ral 7016.

(1-piece package)  
**OUTDOORS - MAGAZINE FORMAT**  
 Mailbox in die-cast aluminium Ral 7016 anthracite finish.

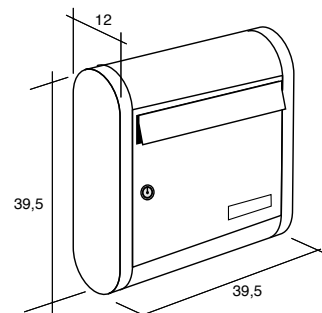

# Serie MAGNUM



(confezione da 1 pezzo)  
**PER ESTERNO - FORMATO RIVISTA**  
 Cassetta postale a misura europea in acciaio inox o lamiera zincata con copriferitoia in profilato d'alluminio.

(1-piece package)  
**OUTDOORS - MAGAZINE FORMAT**  
 Stainless steel or galvanized sheet steel mailbox to European standard size with aluminium profile slot flap.

**RITIRO ANTERIORE**

- M2IX** • In acciaio inox 18/10 finitura TDL (Tela Di Lino)
- M2VGH** • In lamiera zincata verniciata grigio antracite Ral 7016.

**FRONT ACCESS**

- M2IX** • 18/10 S/S - TDL finish
- M2VGH** • Galvanized sheet steel Ral 7016 anthracite finish.

**RITIRO POSTERIORE**

- M1IX** • In acciaio inox 18/10 finitura TDL
- M1VGH** • In lamiera zincata verniciata grigio antracite Ral 7016.

**REAR ACCESS**

- M1IX** • 18/10 S/S - TDL finish
- M1VGH** • Galvanized sheet steel Ral 7016 anthracite finish.

(confezione da 1 coppia)  
**MPL\*** La cassetta può essere montata su pali autoportanti (vedi pag.87).

(1-pair package)  
**MPL\*** Mailbox can be mounted on freestanding columns (see page 87).



M2IX

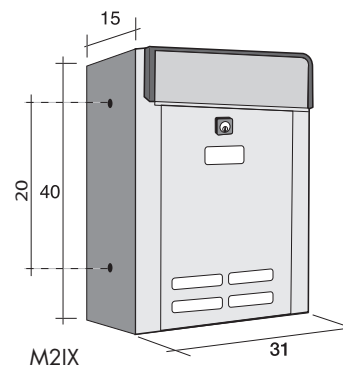
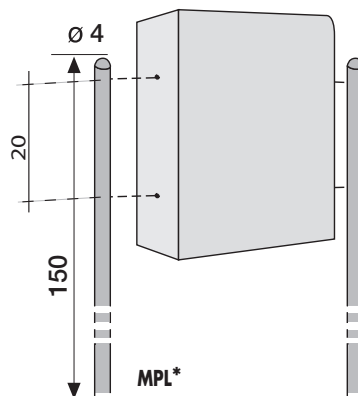

M1VGH

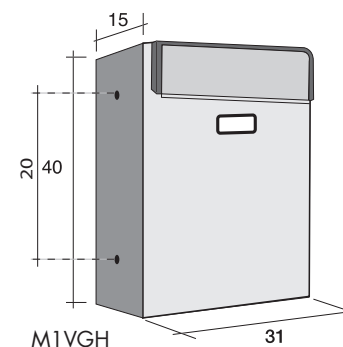

# Ricevi i tuoi pacchi anche



# PACCOBOX XL



17PACCOBOXXLGH



CASSETTE  
PORTAPACCHI

**Cassetta Portapacchi di grandi dimensioni** adatta per custodire i tuoi acquisti dal web mentre sei fuori casa.

**PaccoBox XL** può essere integrata in un casellario postale condominiale compatibilmente alle dimensioni dello stesso.

Costruita in lamiera zincata verniciata alle polveri in colore **grigio antracite** Ral 7016 e dotata di **sportello con chiusura a tre punti** per renderla ancora più robusta.

**Capacità massima: dimensioni pacco**  
cm 36 x 51 x 28

**Large size parcelbox.** Safe lock for your online purchases while you are not home.

**PaccoBox XL** can be integrated in a bank of multiple mailboxes compatibly with mailbox configuration dimensions.

Electro-galvanised sheet metal, powder painted in **anthracite finish (RAL 7016)**.

**Door with 3 locking points to assure its firmness.**

**Max. capacity for parcel**  
cm 36 x 51 x 28



Modalità APRIBILE - OPEN position



**Modalità CHIUSA**  
Lo sportello diventerà apribile solo con la chiave.  
**CLOSED position**  
From now on, the parcel box can be opened only with the key.



**Modalità APERTURA con chiave**  
Ritirato il pacco la serratura può essere riportata in posizione APRIBILE per una nuova consegna.  
**CLOSED position OPENS only with key**  
Lock can be then reset in the OPEN position.

Grazie alla sua speciale serratura, consente al **corriere di consegnare un pacco** e di **bloccare la serratura** che diventerà apribile solo con la chiave.

Thanks to its special lock, it enables the courier to deliver a parcel and block the lock, that can be opened only with its key.



# quando non sei a casa

## EASY BOX



60EASYBOXARL



60EASYBOXGH



# CASSETTE PORTAPACCHI



**Easybox è componibile** ed è possibile realizzare casellari postali condominiali.

Costruita in lamiera zincata verniciata alle polveri in colore **argento** Ral 9006 o **grigio antracite** Ral 7016. Lo sportello è dotato di anti-prelievo con flap e portanome (personalizzabile con incisione) in profilato d'alluminio anodizzato argento.

**Capacità massima: dimensioni pacco cm 36 x 17 x 24**

*Easybox is suitable to create banks of multiple mailboxes.*

*Electro-galvanised sheet metal, powder painted in anthracite finish (RAL 7016) and silver grey (RAL 9006).*

*Door with anti-extraction device and anodized aluminium name card that can be engraved.*

**Max. capacity for parcel cm 36 x 17 x 24**

**Posizione Chiuso**  
Apri  
**SENZA chiave**

**Posizione Aperto**

**Posizione Chiuso**  
Apri  
**SOLO con chiave**

---

**Closed Position**  
Open  
**WITHOUT key**

**Open Position**

**Closed Position**  
Opens  
**ONLY with key**

Cassetta postale per esterni con Vano Portapacchi dotato di serratura PBlock che consente al corriere di consegnare un pacco e di bloccare la serratura che diventerà apribile solo con la chiave.

La serratura della posta ha la stessa chiave del vano portapacchi.

*Mailbox with parcel container for outdoor and indoor installation. With PBlock, that enables the courier to deliver a parcel and block the lock, that can be opened only with its key.*

*Same key for mailbox's and parcel container's lock.*



Composizioni disponibili - Compositions available

132,00	120,00	108,00	96,00	84,00	72,00	60,00	48,00	36,00
99,00	88,00	76,00	64,00	52,00	40,00	28,00	16,00	4,00
66,00	56,00	44,00	32,00	20,00	8,00	0,00	0,00	0,00
33,00	24,00	16,00	8,00	0,00	0,00	0,00	0,00	0,00
cm	40,00	80,00	120,00	160,00	200,00	240,00		

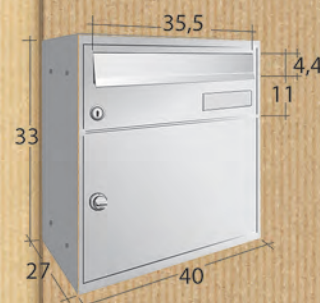



# CASSETTE PORTAPACCHI

Esempi di installazione - Examples of installation

## PACCOBOX



## EASY BOX



## Serie PORTAPANE

Esterno **formato RIVISTA** MODELLO CONFORME EN 13724



(confezione da 1 pezzo)

**PER ESTERNO - FORMATO RIVISTA  
PORTAPANE**

**PPP1GH** • Cassetta postale composta da box portalettere più box portapane. Colore grigio antracite Ral 7016.

**PPP2GH** • Cassetta postale **passante** composta da box portalettere più box portapane.

(confezione da 1 coppia)

**MPL\*** La cassetta può essere montata su pali autoportanti (vedi pag.87).

(1-piece package)

**OUTDOORS - MAGAZINE FORMAT  
PORTAPANE**

**PPP1GH** • Mailbox composed of mailbox and bread box.

Color: anthracite finish (Ral 7016).

**PPP2GH** • **Through mounting** bread box, composed of mailbox and bread box.

(1-pair package)

**MPL\*** Mailbox can be mounted on freestanding columns (see page 87).

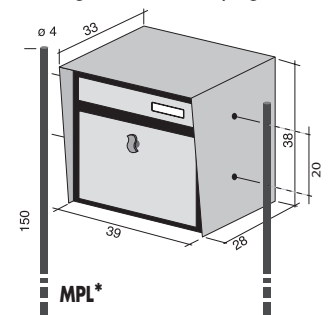

PPP1GH  
Fronte - Front view



PPP1GH  
Retro - Rear view



PPP2GH  
Fronte - Front view



PPP2GH  
Retro - Rear view

# COPRIFERITOIA

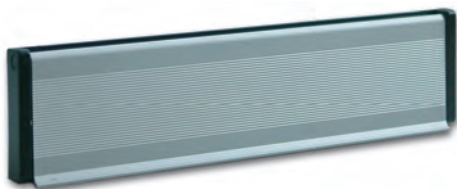

CFRAR



CFRNE

(confezione da 6 pezzi)  
**PER ESTERNO - FORMATO RIVISTA**  
**CFR**

Copriferitoia in profilato di alluminio disponibile nei colori:

- Anodizzato argento
- Verniciato nero



(6-piece package)  
**OUTDOORS - MAGAZINE FORMAT**  
**CFR**

Aluminium profile slot flap.

Colors available:

- anodized - silver
- painted - black

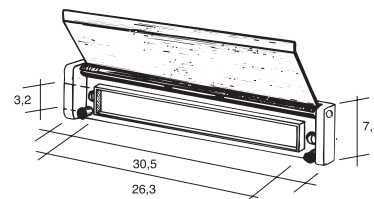

MADE IN CHINA

# RACCOGLIPOSTA RCP



RCPGH



(confezione 4 pezzi)  
**PER ESTERNO - FORMATO RIVISTA**

Cassetta raccogli posta in lamiera di acciaio verniciata colore grigio antracite Ral 7016. Adattabile alle copriferitoie CFR e CFR Ottone (vedi pag. 95) e alle placche in ottone (vedi da pag. 92 a 94).

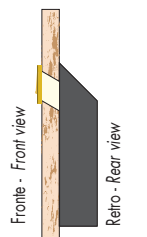

Porta vista in sezione  
 Door sectional view

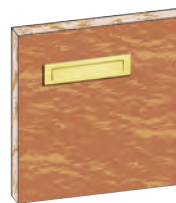

Esterno  
 External view



Interno  
 Internal view

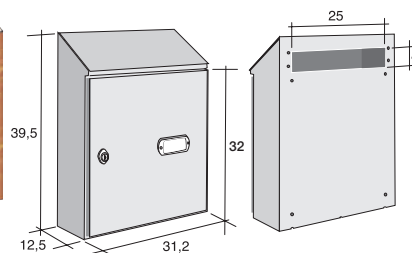

(4-pieces package)  
**OUTDOORS - MAGAZINE FORMAT**

Sheet steel mail collection box, in anthracite finish (Ral 7016). Suitable for slot flaps CFR and Brass CFR (see pages 95), and brass slot plates (see from page 92 to 94).

**INSTALLAZIONE SU PORTA O PARETE**

Esempio di installazione con cassetta raccogliposta RCP + copriferitoia di ottone CFROL (vedi pag 94).

**DOORS AND FACE INSTALLATION**

Example of installation with RCP mail collection box + CFROL brass slot flap (see page 94).

MADE IN ITALY

# RACCOGLIPOSTA M4



M4GH



(confezione 6 pezzi)  
**PER ESTERNO - FORMATO RIVISTA**

Cassetta raccogli posta in alluminio anodizzato con sportello verniciato grigio antracite Ral 7016. Adattabile alle copriferitoie CFR e CFR Ottone (vedi pag. 95) e alle placche in ottone (vedi da pag. 92 a 94). Elemento mobile bloccato.

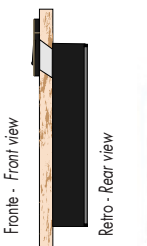

Porta vista in sezione  
 Door sectional view



Esterno  
 External view



Interno  
 Internal view

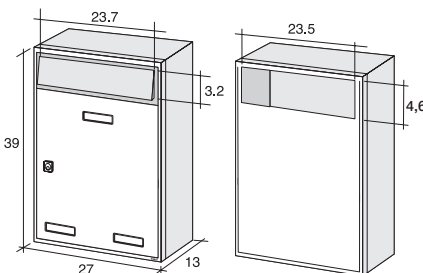

(6-pieces package)  
**OUTDOORS - MAGAZINE FORMAT**

Anodized aluminium mail collection box with door, anthracite finish (Ral 7016). Suitable for slot flaps CFR and Brass CFR (see pages 95), and brass slot plates (see from page 92 to 94). Rear view with fastened flap

**INSTALLAZIONE SU PORTA O PARETE**

Esempio di installazione con cassetta raccogliposta M4 + placca ottone A3 GH (vedi pag 91).

**DOORS AND FACE INSTALLATION**

Example of installation with M4 mail collection box + A3 GH brass slot plate (see page 91).

ESEMPIO  
 abbinato a  
 copriferitoia ottone  
**EXAMPLE**  
 with brass slot flap

# SPORTELLI SC1



SC1GH

SC1AR

(confezione da 4 pezzi)

## PER ESTERNO

cm 23 x 33 (dimensioni incasso)  
In alluminio anodizzato argento e verniciato grigio antracite Ral 7016. (Kit di 4 murature in dotazione).



(4-pieces package)

## OUTDOORS

23 x 33 cm (recess dimensions)  
In silver anodized aluminium and anthracite finish (Ral 7016). (Kit of 4 wall mounts supplied).

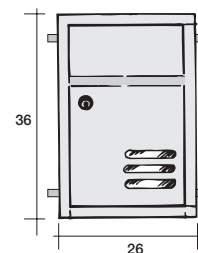

# SPORTELLI SC2

**Gli sportelli SC1-SC2 sono SPROVVISTI di feritoie per l'introduzione della posta.**

**SC1-SC2 doors are not equipped with slot to insert mail.**



SC2GH



SC2BR

(confezione da 4 pezzi)

## PER ESTERNO

cm 26 x 37 (dimensioni incasso)  
In alluminio anodizzato bronzo e verniciato grigio antracite Ral 7016. (Kit di 4 murature in dotazione).

(4-pieces package)

## OUTDOORS

26 x 37 cm (recess dimensions)  
In bronze anodized aluminium and anthracite finish (Ral 7016). (Kit of 4 wall mounts supplied).

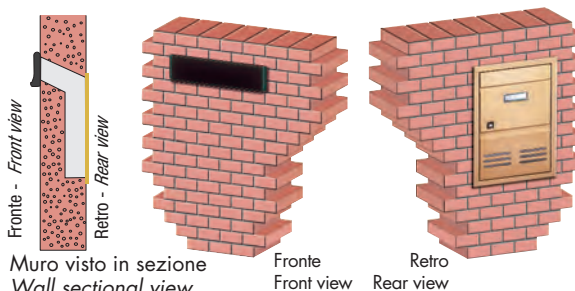

Muro visto in sezione  
Wall sectional view

Fronte  
Front view

Retro  
Rear view

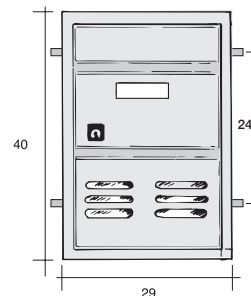

Esempio di installazione con sportello SC2 sul retro e copriferitoia CFR (pag 85) sul fronte.

Example of installation with SC2 door on the back and CFR slot flap on the front (see page 85).

# FRONTALI SC4



SC4GH



SC4AR

**I frontali sono DOTATI di feritoie per l'introduzione della posta.**

**Front plates are equipped with slot to insert mail.**

(confezione 2 pezzi)

## PER ESTERNO - FORMATO RIVISTA

cm 26 x 43 (dimensioni incasso)  
Frontale da incasso in alluminio anodizzato con elemento mobile. Disponibile nei colori verniciato grigio antracite Ral 7016 e anodizzato argento. (Kit di 4 murature in dotazione).

(2-pieces package)

## OUTDOORS - MAGAZINE FORMAT

26 x 43 cm (recess dimensions)  
Front plate in anodized aluminium for recess mounting, with moving element. Paint finish available in anthracite finish (Ral 7016) and anodized silver colors. (Kit of 4 wall mounts supplied).

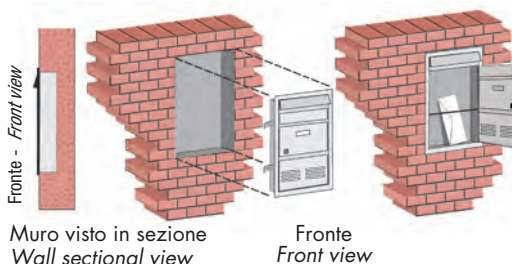

Muro visto in sezione  
Wall sectional view

Fronte  
Front view

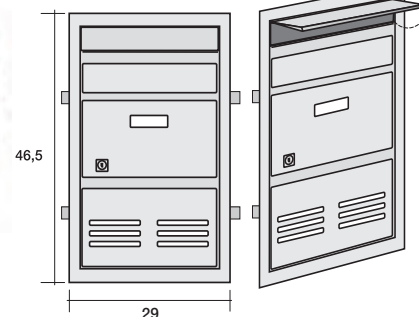

Esempio di installazione con frontale SC4.  
Example of installation with SC4 front plate.

# Serie COMBI

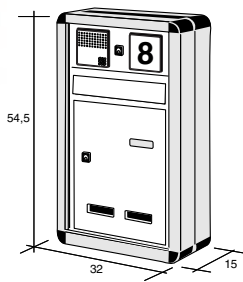

Combi ACC Montecarlo prelievo frontale - front access

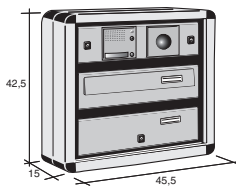

Combi 1 prelievo frontale - front access

## Accessori non forniti

(confezione da 1 pezzo)

**COMBI ACC - Montecarlo - 1 - 3 - 3/2**  
Cassette Postali in profilato di alluminio con mantello per esterni o con cornice coprifuga da incasso.

**Montecarlo - Combi 1 - prelievo frontale, predisposta** per accessori BTicino Sfera e New Sfera. Colori disponibili: Combi 1, vedi Modular 1 pag. 23. Montecarlo, vedi pag. 37

**Combi - 3 prelievo frontale - Combi 3/2 - prelievo posteriore, con placca porta accessori** per: Bpt Serie Targha - BTicino Serie Minisfera, New Sfera and Robur - Elvox Serie Galileo - Urmet Serie Sintesi. Colori disponibili: vedi Modular 3 pag. 37

## Accessories not supplied

(1-pc package)

**COMBI ACC - Montecarlo - 1 - 3 - 3/2**  
Mailboxes with intercom, in aluminium profile with outer casing for outdoor use or cover frame, for recessed mounting.

**Montecarlo - Combi 1 - front access, configured for the following accessories:** BTicino Sfera and New Sfera. Colors available: Combi 1, see Modular 1 page 23. Montecarlo, see page 37

**Combi - 3 front access - Combi 3/2 - rear access, configured for the following accessories:** Bpt Series Targha - BTicino Series Minisfera, New Sfera and Robur - Elvox Series Galileo - Urmet Series Sintesi. Colors available: see Modular 3 page 37



Combi 3 - mantello - outer casing prelievo frontale - front access



Combi 3 - cornice - external frame prelievo frontale - front access



Combi 3/2 - cornice - external frame PRELIEVO POSTERIORE - REAR ACCESS

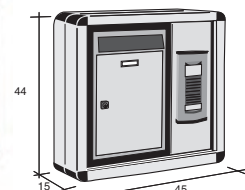

## ACCESSORI - ACCESSORIES

### MANTELLO CORNICE - PALI

#### PER ESTERNO

Mantello e Cornice - in alluminio per Giove e Venere vedi pag.40-41

MPL - Pali elettrozincati e verniciati alle polveri di colore nero per esterno per Marte, Giove, Venere, Magnum e Portapane.

(confezione da 1 coppia)

#### OUTDOORS

Aluminium outer casing and frame for Giove and Venere see page 40-41

MPL - Electrogalvanized stands for outdoors, black epoxy powder painted. Suitable for Marte, Giove, Venere, Magnum e Portapane.

(1-pair package)

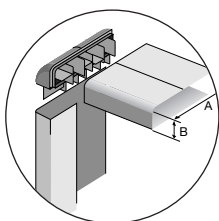

Mantello - Casing

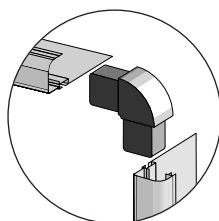

Cornice - Frame

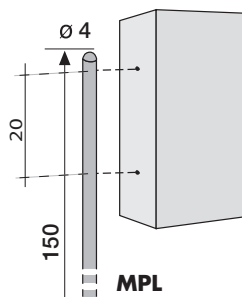

MPL

### Traversini per fissaggio a barriera

(confezione da 18 coppie)

Traversini in profilato di alluminio per il fissaggio delle cassette alla recinzione:

**TR 160** • Per tutti i modelli escluso Magnum 2, Modular 3, Giove, Marte e Saturno.

**TR 260** • Per Magnum 2 e Modular 3

**TR 300** • Per Marte, Giove e Saturno

Le viti 4 MA sono fornite lunghe mm 50 e vanno tagliate in funzione dello spessore della recinzione.

(18-pair package)

Aluminium profile braces for fixing mailboxes to fencing.

**TR 160** • For all models except Magnum 2, Modular 3, Giove, Marte and Saturno.

**TR 260** • For Magnum 2 and Modular 3

**TR 300** • For Marte, Giove and Saturno

The 4 MA screws provided are 50 mm long and should be cutted according to the thickness of the fencing.

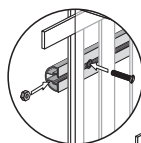

### PORTA NOME

Portanome universale in plastica a incasso per esterno o interno con cartoncino.



Universal nameplate for outdoors or indoors in plastic material equipped with cad snap-kit.

Portanome universale adesivo colore ottone



per esterno o interno da incidere o personalizzare con pennarello indelebile.

Universal nameplate for outdoors or indoors in brass colour and adhesive to engrave or customized with lasting marker.

### CHIAVI E SERRATURE

Kit Serratura TONDA per Serie:

**ROUND lock for Series:**

- Regie Poste - Prima - Prima Maxi - Chalet - Villa
- Quadra - Pechino - Ibiza - Mia - Raccogliposta.

Kit Serratura QUADRATA per Serie:

**SQUARE lock for Series:**

- Effe T - Sirio - Uno Maxi.

Kit Serratura OTTONE per Serie:

**BRASS lock for Series:**

- Residence - Europa - Lettere.





## Kit Pubblicità



### ESEMPI

Esempi di cassette postali trasformate in cassette porta pubblicità con l'apposito kit.  
Examples of mailboxes complete of publicity label and thumb latch suitable for advertising.

(confezione da 1 pezzo)

**KITPUB** • Serratura a cricchetto + targhetta adesiva di cm 24,5 x 6 da applicare sulle cassette postali per trasformazione in cassetta per pubblicità.



NON APRIRE AGLI SCONOSCIUTI!



NON CONFONDERE LA TUA POSTA PRIVATA CON LA RECLAME!

Esterno

(1-piece package)

**KITPUB** • Thumb latch + 24.5 x 6 cm adhesive nameplate for application to convert mailbox into advertising version.

MADE IN ITALY

## CAROSELLO Pubblicità



CAROSELLOGH



Colore inalterabile nel tempo



Resistente al gelo



Resistente al caldo



Resistente all'umidità

(confezione da 4 pezzi)

### PER ESTERNI

Cassetta per pubblicità in policarbonato di colore grigio antracite.

(4-pieces package)

### OUTDOORS

Anthracite color polycarbonate box for publicity.

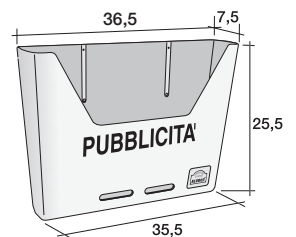

MADE IN ITALY

## BUSTA Pubblicità



BUSTAPUBGH

Design innovativo.

Ampia parte frontale trasparente che rende agevole la visione del contenuto.  
Ampio sportello che consente di prelevare facilmente la pubblicità.  
Resistente all'acqua e alla ruggine.

(confezione da 2 pezzi)

### PER ESTERNI

Cassetta per la pubblicità in lamiera elettrozincata colore grigio antracite Ral 7016 e sportello in plexiglass trasparente.

NON APRIRE AGLI SCONOSCIUTI!



NON CONFONDERE LA TUA POSTA PRIVATA CON LA RECLAME!

Esterno

Innovative design.

Large transparent front door to see inside.  
Large door to pickup easily.  
Water resistant and warranty corrosion proof.

(2-pieces package)

### OUTDOORS

Box for publicity in electrogalvanized sheet steel in anthracite finish (Ral 7016) and transparent plexiglass door.

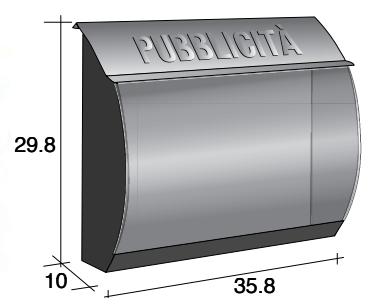

# RECLAME Pubblicità

NON APRIRE  
AGLI  
SCONSCIUTI!

NON CONFONDERE  
LA TUA POSTA PRIVATA  
CON LA RECLAME!

Esterno



RECLAMEGH

(confezione da 2 pezzi)

## PER ESTERNI

Cassetta per la pubblicità in lamiera zincata verniciata alle polveri disponibile nei colori grigio antracite Ral 7016 e argento sabbiato.



RECLAMEAR

(2-pieces package)

## OUTDOORS

Galvanized sheet steel mailbox for advertising epoxy powder painted. Colors available: anthracite finish (Ral 7016) and sand-blasted silver.

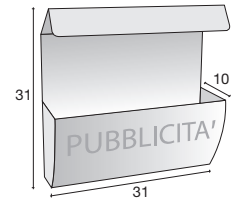

# RECLAME MAXI Pubblicità

NON APRIRE  
AGLI  
SCONSCIUTI!

NON CONFONDERE  
LA TUA POSTA PRIVATA  
CON LA RECLAME!

Esterno

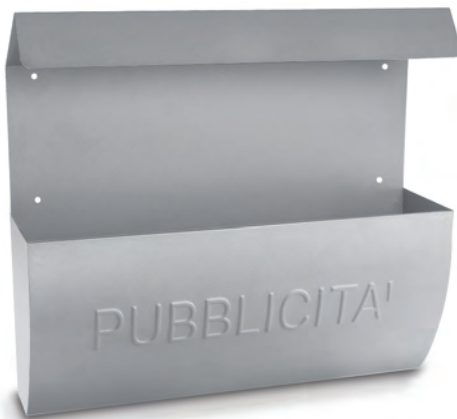

RECLAMEMAXIAR

(confezione da 2 pezzi)

## PER ESTERNI

Cassetta per la pubblicità in lamiera zincata verniciata alle polveri colore argento sabbiato.

(2-pieces package)

## OUTDOORS

Galvanized sheet steel mailbox for advertising epoxy powder painted sand-blasted silver color.

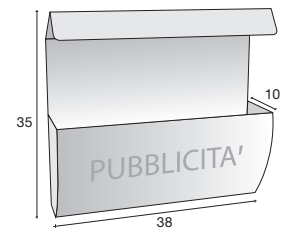

# MARSUPIO Pubblicità

NON APRIRE  
AGLI  
SCONSCIUTI!

NON CONFONDERE  
LA TUA POSTA PRIVATA  
CON LA RECLAME!

Esterno



MARSUPIOGH

(confezione da 2 pezzi)

## PER ESTERNI

Cassetta per la pubblicità in lamiera zincata verniciata alle polveri disponibile nei colori grigio antracite Ral 7016 e argento sabbiato.



MARSUIOAR

(2-pieces package)

## OUTDOORS

Galvanized sheet steel mailbox for advertising epoxy powder painted. Colors available: anthracite finish (Ral 7016) and sand-blasted silver.

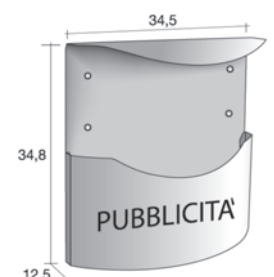

# HELLAS Pubblicità

NON APRIRE AGLI SCONOSCIUTI!  
NON CONFONDERE LA TUA POSTA PRIVATA CON LA RECLAME!



HELLASGH

(confezione da 2 pezzi)  
**PER ESTERNI**

Cassetta per la pubblicità in lamiera zincata verniciata alle polveri disponibile nei colori bianco e grigio antracite Ral 7016.



HELLASBI

(2-pieces package)  
**OUTDOORS**

Galvanized sheet steel mailbox for advertising epoxy powder painted. Colors available: white and anthracite finish (Ral 7016).

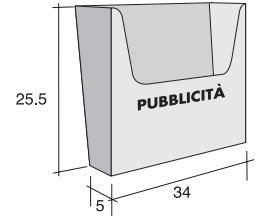

# HELLAS MAXI Pubblicità

NON APRIRE AGLI SCONOSCIUTI!  
NON CONFONDERE LA TUA POSTA PRIVATA CON LA RECLAME!



HELLASMAXIGH

(confezione da 2 pezzi)  
**PER ESTERNI**

Cassetta per la pubblicità di formato maxi in lamiera elettrozincata disponibile nel colore grigio antracite Ral 7016.

**TETTO PER HELLAS MAXI.**

(confezione da 1 pezzo)  
Tetto fornito a parte solo per Hellas maxi disponibile nel colore grigio antracite Ral 7016.

(2-pieces package)  
**OUTDOORS**

Extra-large format box for publicity in electrogalvanized sheet steel in anthracite finish (Ral 7016).

**WEATHER HOOD FOR HELLAS MAXI.**

(1-piece package)  
Separate weather hood for Hellas maxi only. Colors available: anthracite finish (Ral 7016).

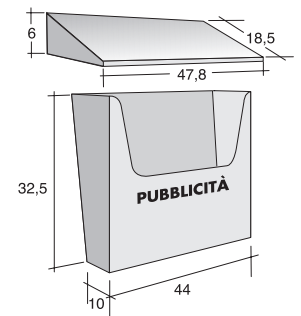

Esempi di installazione  
Examples of installation



# Serie OTTONE - *BRASS Series*



**ALUBOX**

*Cassette Postali - Mailboxes*

Serie **RESIDENCE OTTONE**

RESOL - ottone lucido  
RESOL - polished brass



RESOB - ottone brunito  
RESOB - burnished brass



RESOGH - ottone verniciato grigio antracite Ral 7016  
RESOGH - brass anthracite finish (Ral 7016)

**Tetto fisso - Protetta da vernicetta fissata a forno**

(confezione 1 pezzo)

**PER ESTERNO - FORMATO RIVISTA**

Cassetta postale con prelievo frontale,  
protetta da vernicetta fissata a forno.

**RESOL** • ottone lucido

**RESOB** • ottone brunito

**RESOGH** • ottone verniciato grigio antracite Ral 7016

**Fixed overplate - With rust-proof paint**

(1-piece package)

**OUTDOORS - MAGAZINE FORMAT**

Front access mailbox,  
protected with oven-baked varnish.

**RESOL** • polished brass

**RESOB** • burnished brass

**RESOGH** • brass anthracite finish (Ral 7016)

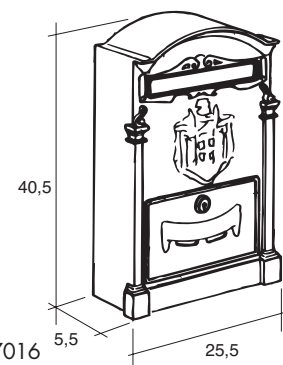
Serie **ANTICA OTTONE A2**

*ad esaurimento*



A2OGH

(confezione 1 pezzo)

**PER ESTERNO - FORMATO RIVISTA**

Frontale da incasso in fusione di ottone  
con prelievo frontale.

**A2OGH** • ottone verniciato grigio antracite Ral 7016

**A2OB** • ottone brunito

(1-piece package)

**OUTDOORS - MAGAZINE FORMAT**

Cast brass front plate for recess mounting  
front access.

**A2OGH** • brass anthracite finish (Ral 7016)

**A2OB** • burnished brass



A2OB

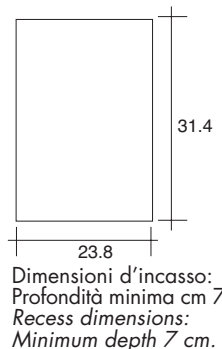

Dimensioni d'incasso:  
Profondità minima cm 7  
Recess dimensions:  
Minimum depth 7 cm.

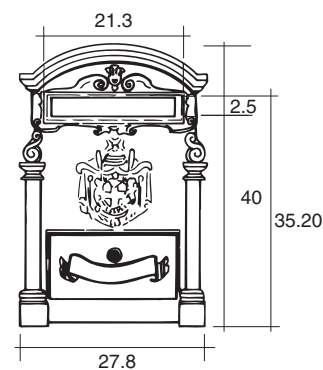
Serie **ANTICA OTTONE A3**

A3GH

(confezione 1 pezzo)

**PER ESTERNO - FORMATO RIVISTA**

Placca bucalettere in ottone  
con prelievo posteriore.

**A3OL** • ottone lucido

**A3OB** • ottone brunito

**A3GH** • ottone verniciato grigio antracite Ral 7016

(1-piece package)

**OUTDOORS - MAGAZINE FORMAT**

Brass slot mailbox, rear access.

**A3OL** • polished brass

**A3OB** • burnished brass

**A3GH** • brass anthracite finish (Ral 7016)



A3OB



A3OL

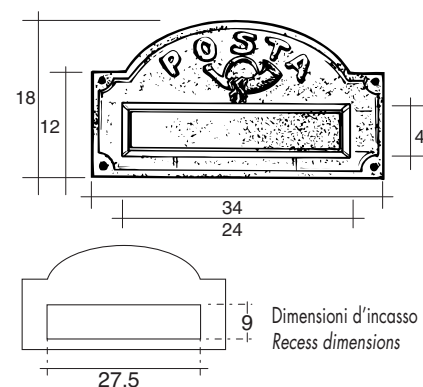

Dimensioni d'incasso  
Recess dimensions

# Serie ANTICA OTTONE A4 *ad esaurimento*

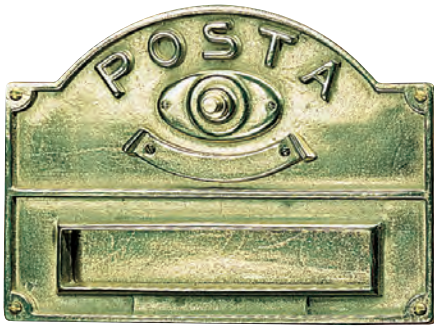

A4OL

(confezione 1 pezzo)  
**PER ESTERNO - FORMATO RIVISTA**  
**A4OL** • Placca bucalettere in ottone lucido con prelievo posteriore.

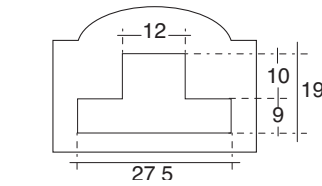

Dimensioni d'incasso - Recess dimensions

(1-piece package)  
**OUTDOORS - MAGAZINE FORMAT**  
**A4OL** • Brass slot mailbox, rear access, in polished brass

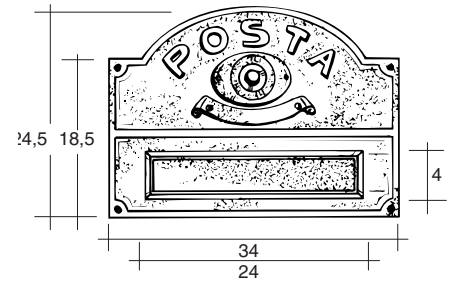

# Serie ANTICA OTTONE A5



A5GH

(confezione 1 pezzo)  
**PER ESTERNO - FORMATO RIVISTA**  
 Placca bucalettere in ottone con prelievo posteriore.  
**A5OL** • ottone lucido  
**A5OB** • ottone brunito  
**A5GH** • ottone verniciato grigio antracite Ral 7016

(1-piece package)  
**OUTDOORS - MAGAZINE FORMAT**  
 Brass slot mailbox, rear access.  
**A5OL** • polished brass  
**A5OB** • burnished brass  
**A5GH** • brass anthracite finish (Ral 7016)

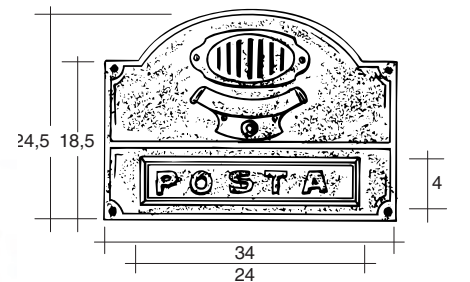

A5OB



A5OL

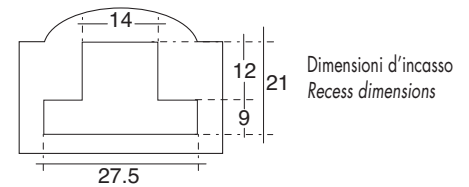

Dimensioni d'incasso  
 Recess dimensions

# Serie ANTICA OTTONE A6



A6GHN

(confezione 1 pezzo)  
**PER ESTERNO - FORMATO RIVISTA**  
 Placca bucalettere in ottone con prelievo posteriore.  
**A6OL** • ottone lucido  
**A6OB** • ottone brunito  
**A6GH** • ottone verniciato grigio antracite Ral 7016

(1-piece package)  
**OUTDOORS - MAGAZINE FORMAT**  
 Brass slot mailbox, rear access.  
**A6OL** • polished brass  
**A6OB** • burnished brass  
**A6GH** • brass anthracite finish (Ral 7016)



A6OBN



A6OLN

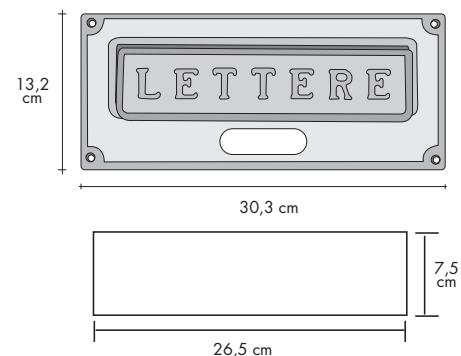

Dimensioni d'incasso - Recess dimensions

Serie **ANTICA OTTONE A7**

A7GH

(confezione 1 pezzo)

**PER ESTERNO - FORMATO RIVISTA**

Placca in ottone verniciato color grigio antracite Ral 7016 per esterni con prelievo frontale. Arricchiscono la nuova placca la griglia citofonica, il campanello, la serratura e altri particolari in ottone lucido.

(1-piece package)

**OUTDOORS - MAGAZINE FORMAT**

Brass front plate, brass anthracite finish (Ral 7016), for outdoors - front access. Available with intercom slits, doorbell, lock and other polished brass accessories.

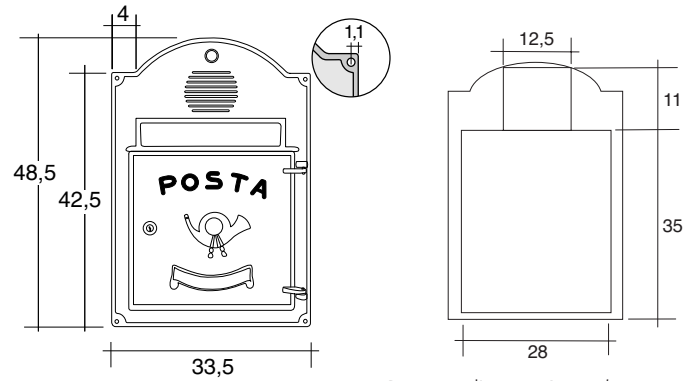

Dimensioni d'incasso - Recess dimensions

Serie **ANTICA OTTONE A8** *ad esaurimento*

A8GH

(confezione 1 pezzo)

**PER ESTERNO - FORMATO RIVISTA**

Placca bucalettere in ottone con prelievo posteriore.

- A8OL** • ottone lucido
- A8OB** • ottone brunito
- A8GH** • ottone verniciato grigio antracite Ral 7016

(1-piece package)

**OUTDOORS - MAGAZINE FORMAT**

Brass slot mailbox, rear access.

- A8OL** • polished brass
- A8OB** • burnished brass
- A8GH** • brass anthracite finish (Ral 7016)



A8OB



A8OL

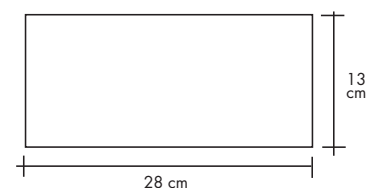
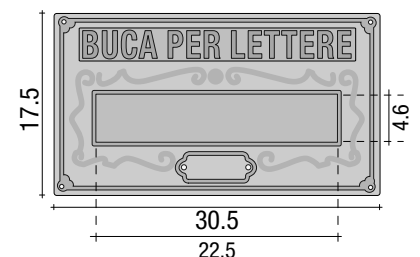

Dimensioni d'incasso - Recess dimensions

# Sportello OTTONE SC3



SC3GH

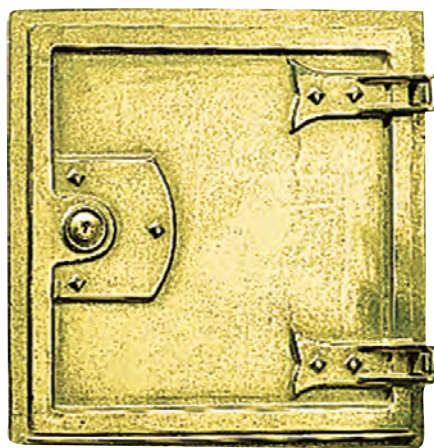

SC3OL

(confezione 1 pezzo)

**PER ESTERNO**

Sportello da incasso in ottone

- SC3OL • ottone lucido
- SC3OB • ottone brunito
- SC3GH • ottone verniciato grigio antracite Ral 7016

(1-piece package)

**OUTDOORS**

Recess mounting brass door

- SC3OL • polished brass
- SC3OB • burnished brass
- SC3GH • brass anthracite finish (Ral 7016)

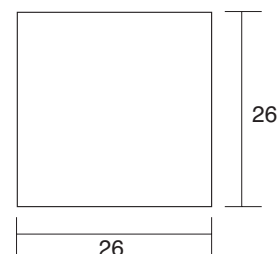
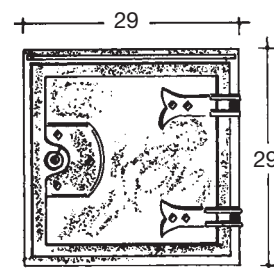

Dimensioni d'incasso - Recess dimensions



SC3OB

# Copriferitoia OTTONE CFR



CFROL



CFROB



CFRGH

(confezione 6 pezzi)

**PER ESTERNO - FORMATO RIVISTA**

Copriferitoia in ottone protetta con vernicetta fissata a forno.

- CFROL • ottone lucido
- CFROB • ottone brunito
- CFRGH • ottone verniciato grigio antracite Ral 7016

(6-pieces package)

**OUTDOORS - MAGAZINE FORMAT**

Brass slot flap protected with over-baked varnish.

- CFROL • polished brass
- CFROB • burnished brass
- CFRGH • brass anthracite finish (Ral 7016)

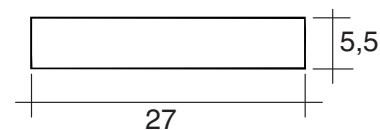
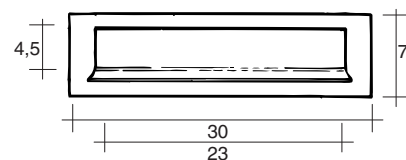

Dimensioni d'incasso - Recess dimensions



# TARGHE OTTONE Porta numeri civici

I numeri sono sempre in ottone lucido indipendentemente dal supporto.

Numbers are always in polished brass, also in the burnished or grey painted version.



TG3GH + NC1GH + NC0GH + NC2GH

(confezione 1 pezzo)

PER ESTERNO

TGOL - TGOB - TGGH

- Targa porta numeri in ottone lucido (OL), brunito (OB) o verniciato grigio antracite Ral 7016 (GH), da 1,2,3,4 numeri

(1-piece package)

OUTDOORS

TGOL - TGOB - TGGH

- Residence number plate in polished (OL) or burnished (OB) brass, or brass anthracite finish, Ral 7016 (GH), with 1,2,3 or 4 numbers.

NCOL - NCOB - NCGH

- Numeri civici in ottone lucido (OL), brunito (OB) o verniciato grigio antracite Ral 7016 (GH) da 0 a 9 e dal 1° al 9°, lettere A, B, C, D, E, F, G, e H.

NCOL - NCOB - NCGH

- Residence numbers in polished (OL), burnished (OB) brass, or cast-iron grey Ral 7016 painted (GH), from 0 to 9 and letters A, B, C, D, E, F, G and H.



TG3OB + NC1OB + NC4OB + NCBOB

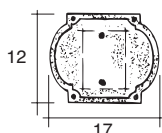

TG1

Da un numero  
Accommodates  
one number

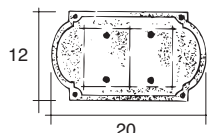

TG2

Da due numeri  
Accommodates  
two numbers

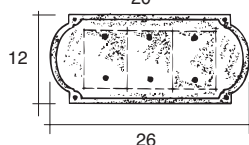

TG3

Da tre numeri  
Accommodates  
three numbers

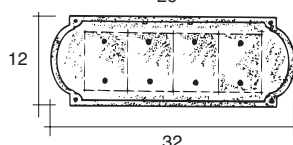

TG4

Da quattro numeri  
Accommodates  
four numbers



TG2OL + NC3OL + NC5OL

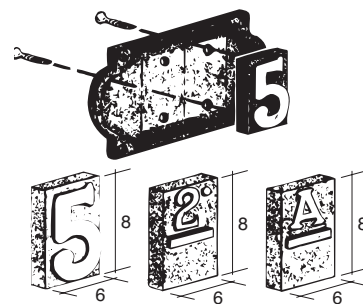

# TARGHE OTTONE Porta nome

adesaurimento



TP1OL

(confezione 1 pezzo)

PER ESTERNO

TP1OL - TP1OB

- Targa portanome in ottone lucido o brunito a un inserto.

TP2OL - TP2OB

- Targa portanome in ottone lucido o brunito a due inserti.

B275/55 OL

- Inserto grande in ottone lucido.

B230/30 OL

- Inserto piccolo in ottone lucido.

(1-piece package)

OUTDOORS

TP1OL - TP1OB

- Single name plate in polished or burnished brass.

TP2OL - TP2OB

- Double name plate in polished or burnished brass.

B275/55 OL

- Polished brass name holder - big size.

B230/30 OL

- Polished brass name holder - small size



TP2OB

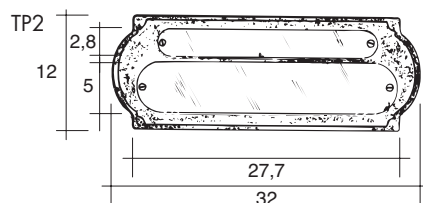
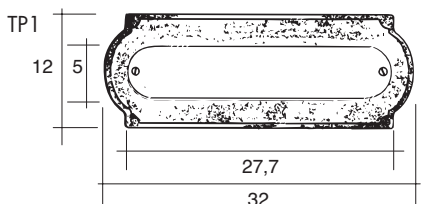

B275/55OL

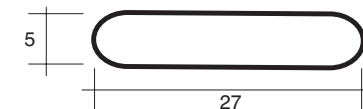

B230/30OL



B275/55OL

# CAMPANELLI OTTONE



CLLEOPOL

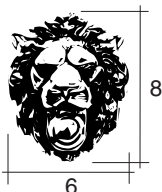

CLLEOOL

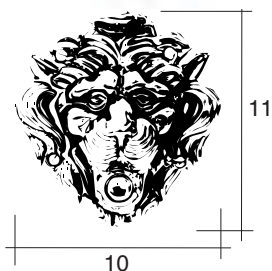

CLVOL

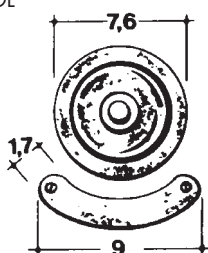

- Se l'impianto è di tipo ANALOGICO collegare il pulsante della pulsantiera al circuito con 2 fili.
- Se l'impianto è di tipo DIGITALE collegare in parallelo il pulsante della pulsantiera al pulsante del circuito digitale.

(confezione 1 pezzo)

## PER ESTERNO

- CLVOL** • Campanello Serie Venezia con portanome in ottone lucido (OL).
- CL** • Campanello in ottone lucido (OL), brunito (OB) o verniciato grigio antracite Ral 7016 (GH).
- CL1** • Campanello in ottone lucido (OL), brunito (OB) o verniciato grigio antracite Ral 7016 (GH) a 1 pulsante.
- CL2** • Campanello in ottone lucido (OL), brunito (OB) o verniciato grigio antracite Ral 7016 (GH) a 2 pulsanti.
- CLLEOP** • Campanello Leone piccolo in ottone lucido (OL).
- CLLEO** • Campanello Leone grande in ottone lucido (OL) o anticato (OB).

- If the system is ANALOGIC: connect the push-button of the panel to the circuit with 2 wires.
- If the system is DIGITAL: connect the push-button of the panel in parallel to the push-button of the circuit.

(1-piece package)

## OUTDOORS

- CLVOL** • Polished brass Venezia series doorbell plate with name holder (OL).
- CL** • Doorbell plate in polished (OL) or burnished (OB) brass, or anthracite finish, Ral 7016 (GH).
- CL1** • One button doorbell plate in polished (OL) or burnished (OB) brass, anthracite finish, Ral 7016 (GH).
- CL2** • Two buttons doorbell plate in polished (OL) or burnished (OB) brass, anthracite finish, Ral 7016 (GH).
- CLLEOP** • Small Lion doorbell plate in polished (OL) brass.
- CLLEO** • Big Lion doorbell plate in polished (OL) or burnished (OB) brass.



CLGH



CL1OL



CLVOL



CL2OL

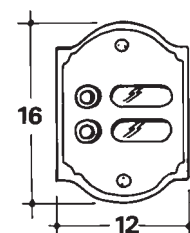
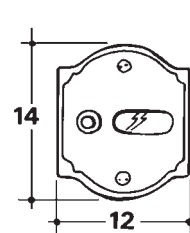
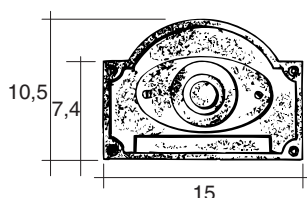

# PULSANTIERE OTTONE



PLS1GH



PLS1OB



PLS1OL



PLS2GH + PLTPGH



PLS2OB



PLS2OL



PLS4OL + PLTPOL



PLTOL



PLTPOL

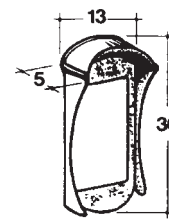

PLTOL

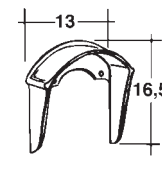

PLTPOL

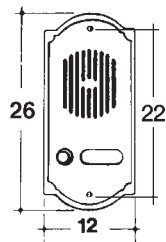

PLS1

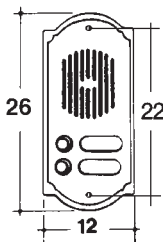

PLS2

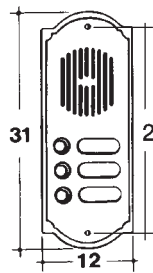

PLS3

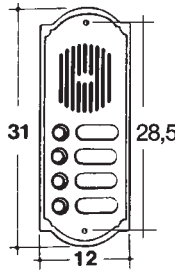

PLS4

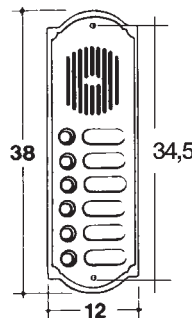

PLS6

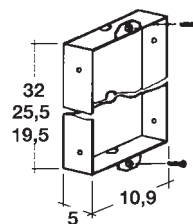

- Se l'impianto è di tipo ANALOGICO collegare il pulsante della pulsantiera al circuito con 2 fili.
- If the system is ANALOGIC: connect the push-button of the panel to the circuit with 2 wires.
- Se l'impianto è di tipo DIGITALE collegare in parallelo il pulsante della pulsantiera al pulsante del circuito digitale.
- If the system is DIGITAL: connect the push-button of the panel in parallel to the push-button of the circuit.

(confezione 1 pezzo)

## PER ESTERNO

Pulsantiera con feritoie per citofono ad 1-2-3-4-6 campanelli in ottone lucido (OL), brunito (OB) o verniciato grigio antracite Ral 7016 (GH) completa di KITPLS per protezione parte elettrica.

- PLTP** • Tettuccio esterno per protezione pulsantiera a 1, 2, 3, 4, 6 campanelli in ottone lucido (OL), anticato (OB) o verniciato grigio antracite Ral 7016 (GH)
- PLT** • Tettuccio esterno per protezione pulsantiera a 1 e 2 campanelli in ottone lucido (OL), anticato (OB) o verniciato grigio antracite Ral 7016 (GH).
- KITPLS** • Kit di protezione parte elettrica in lamiera zincata in 3 dimensioni per le pulsantiere: PLS 1-2-3-4-6

(1-piece package)

## OUTDOORS

Bell plate with intercom slits for 1-2-3-4 or 6 bells, in polished (OL) or burnished (OB) brass or anthracite finish, Ral 7016 (GH), complete with KITPLS to protect electric components.

- PLTP** • Weather hood to protect the bell plate for 1, 2, 3, 4, 6 bells in polished (OL) or burnished (OB) brass, or anthracite finish, Ral 7016 (GH).
- PLT** • Weather hood to protect 1 and 2 buttons bell plate, in polished (OL) or burnished (OB) brass, or anthracite finish, Ral 7016 (GH)
- KITPLS** • Galvanized steel protection kit for electric components, 3 sizes, for bell plates: PLS 1-2-3-4-6

Per fissare i vari tipi di porter per citofono usare nastro di lamiera forata, non in dotazione, reperibile in commercio.

To fix the various types of intercom electrical boxes, use commercially available perforated sheet metal (not provided).

# PULSANTIERE OTTONE



PLS8GH



PLS12OB



★ PLS1TC



★ PLS2TCOL



★ PLS1TCGH

- Se l'impianto è di tipo ANALOGICO collegare il pulsante della pulsantiera al circuito con 2 fili.
- Se l'impianto è di tipo DIGITALE collegare in parallelo il pulsante della pulsantiera al pulsante del circuito digitale.

- If the system is ANALOGIC: connect the push-button of the panel to the circuit with 2 wires.
- If the system is DIGITAL: connect the push-button of the panel in parallel to the push-button of the circuit.

★ I moduli del citofono e telecamera (porter) devono essere separati.

★ Intercom and videocamera modules must be separated.

(confezione 1 pezzo)

### PER ESTERNO

Pulsantiera con feritoie per citofono a 8, 10 e 12 campanelli in ottone lucido (OL), brunito (OB) o verniciato grigio antracite Ral 7016(GH) completa di KITPLS per protezione parte elettrica.

\* Pulsantiera a 10 e 12 campanelli disponibile solo in ottone brunito (OB) o verniciato grigio antracite Ral 7016(GH).

\* Pulsantiera a 8 campanelli disponibile solo in ottone lucido (OL) o verniciato grigio antracite Ral 7016(GH).

**KITPLS** • per protezione parte elettrica in lamiera zincata in 3 dimensioni per le pulsantiere: PLS 8 - 10 - 12

(1-piece package)

### OUTDOORS

Bell plate with intercom slits for 8, 10 and 12 bells, in polished (OL) or burnished (OB) brass or anthracite finish, Ral 7016 (GH), complete with KITPLS to protect electric components.

\* Bell plate for 10-12 bells available only in burnished (OB) brass or anthracite finish, Ral 7016 (GH).

\* Bell plate for 8 bells available only in polished (OL) brass or anthracite finish, Ral 7016 (GH).

**KITPLS** • Galvanized steel protection kit for electric components, 3 sizes, for bell plates: PLS 8 - 10 - 12

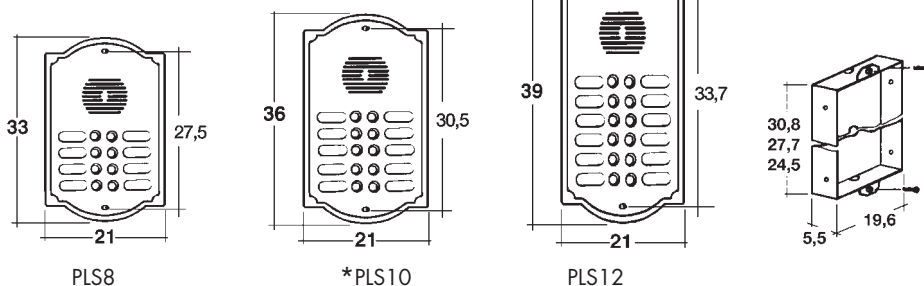

(confezione 1 pezzo)

### PER ESTERNO

**PLS1TC** • Pulsantiera a 1 o 2 campanelli in ottone PLS2TC lucido (OL), ottone anticato (OB) o verniciato grigio antracite Ral 7016 (GH) con feritoie per citofono e sede per telecamera completa di KITPLS per protezione parte elettrica.

**PLTC** • Placca per telecamera in ottone lucido (OL), brunito (OB) o verniciato grigio antracite Ral 7016 (GH) completa di Kit PLTC per protezione parte elettrica.

(1-piece package)

### OUTDOORS

**PLS1TC** • Bell plate with intercom slits for 1 or 2 bells PLS2TC and compartment for camera, in polished (OL) or burnished (OB) brass or anthracite finish, Ral 7016 (GH), complete with KITPLS to protect electric components.

**PLTC** • Camera plate in polished (OL) or burnished (OB) brass or anthracite finish, Ral 7016 (GH), complete with KITPLS Kit to protect electric components.

Per fissare i vari tipi di porter per citofono usare nastro di lamiera forata, non in dotazione, reperibile in commercio.

To fix the various types of intercom electrical boxes, use commercially available perforated sheet metal (not provided).

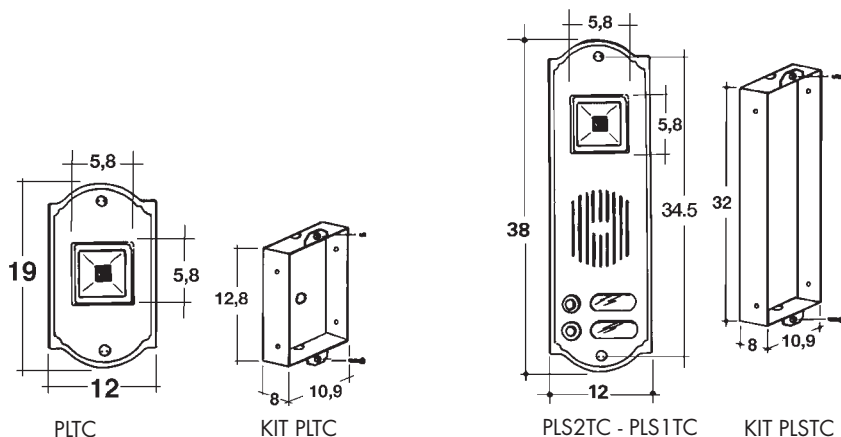

## CAMPANE IN FERRO BATTUTO E OTTONE

(confezione 1 pezzo)

**PER ESTERNO**

**CP135OLG** • Campana in ottone lucido con supporto in ferro battuto. Dim. supporto: altezza cm 35,5; campana Ø cm 13,5.



CP135OLG

**CP135OL** • Campana in ottone lucido con supporto in ferro battuto. Dim. supporto: altezza cm 35; campana Ø cm 13,5.

**CP80OL** • Campana in ottone lucido con supporto in ferro battuto. Dim. supporto: altezza cm 29; campana Ø cm 8.

**CP140OL** • Campana in ottone lucido con supporto in ottone lucido. Dim.: altezza cm 23; campana Ø cm 14.



CP135OL

(1-piece package)

**OUTDOORS**

**CP135OLG** • Polished brass bell with forged iron support. Dimensions: iron support 35,5 cm; bell Ø 13,5 cm.

**CP135OL** • Polished brass bell with forged iron support. Dimensions: iron support 35 cm; bell Ø 13,5 cm.

**CP80OL** • Polished brass bell with forged iron support. Dimensions: iron support 29 cm; bell Ø 8 cm.

**CP140OL** • Polished brass bell with polished brass support. Dimensions: support 23 cm; bell Ø 14 cm.



CP80OL



CP140OL

## CAMPANELLE

• **CP55OL**

Campanello da tavolo piccolo in ottone lucido. Dimensioni: altezza cm 12,5 campana Ø cm 5,5.

• **CP65OL**

Campanello da tavolo grande in ottone lucido. Dimensioni: altezza cm 15,5 campana Ø cm 6,5.

• **CP55OL**

Small desk bell in polished brass. Dimensions: h 12.5 cm bell Ø 5.5 cm

• **CP65OL**

Big desk bell in polished brass. Dimensions: h 15.5 cm bell Ø 6.5 cm



CP 65OL

CP 55OL

## CAMPANELLO DA BANCO

• **CP95OL**

Campanello da banco in ottone lucido. Dimensioni: altezza cm 9 - Ø cm 9,5.

• **CP95OL**

Push bell in polished brass. Dimensions: h 9 cm - bell Ø 9.5 cm



## PORTALETTERE



### Portalettere da tavolo OL/OB

(confezione da 6 pezzi)

- Portalettere da tavolo in ottone lucido (OL) o brunito (OB)

### Desktop letter holder OL/OB

(6-pieces package)

- Desktop letter holder in polished (OL) or burnished (OB) brass.

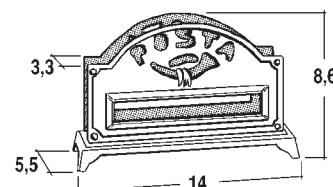



le cose di  
**ALUBOX**

# NUMERI ADESIVI



**RESISTENTI** all'acqua, al sole e al vento  
Per **esterno** e **interni** condominiali  
(adesivo da esterno 3M)

- **VERSATILI**  
si intonano su ogni colore e ad ogni stile
- **FACILI DA APPLICARE**  
senza l'uso di utensili

**48** ore  
**MASSIMA TENUTA**  
dopo 48 ore

(confezione 5 pezzi)  
**NUMERI RESINATI ADESIVI**  
Numeri da 0 a 9  
Lettere dalla A alla E e /•

Wind, sun **RESISTANT** and waterproof  
Suitable for **indoors** and **outdoors**  
(3M stickers for outdoors)

- **SUITABLE**  
for many uses
- **EASY TO FIX**  
without tools

**48** ore  
**STRONG ENDURANCE**  
after 48 hours

(5-pieces package)  
**ADHESIVE NUMBERS**  
Numbers from 0 to 9  
Letters from A to E and /•



Espositore  
da banco.  
Pezzi totali 80  
Counter display  
Total 80 pieces.



# POSACENERE DA TERRA

Esterno **Interno**



(confezione 1 pezzo)

## POSACENERE DA TERRA

In alluminio satinato, con vaschetta portasigarette removibile che permette di non sporcarsi le mani, comprensivo di tasselli per il fissaggio a terra, chiavi e spazzola per la pulizia.

Adatto sia come arredo urbano che per valorizzare interni di prestigio.



(1-piece package)

## FREE STANDING ASHTRAY

In satin aluminium finished, cleaning system that allows to not get dirty hands, includes key, cleaning brush and ground fixing kit, excellent both for urban furniture and the internals valorisation prestige.

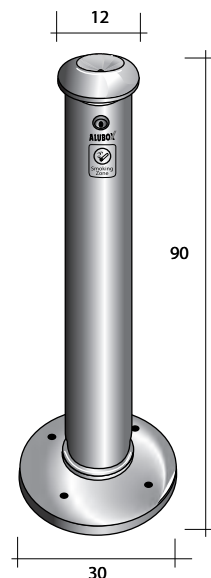

# POSACENERE DA MURO

Esterno **Interno**



(confezione 1 pezzo)

## POSACENERE DA MURO

In alluminio satinato, con apertura sul fondo che permette di rimuovere le sigarette senza sporcarsi le mani. Adatto sia come arredo urbano che per valorizzare interni di prestigio, include chiave e spazzola per pulizia e kit di viti per fissaggio a muro.

(1-piece package)

## WALL MOUNTING ASHTRAY

In satin aluminium finished, with opening on the bottom for cleaning that allows to not get dirty hands, Excellent both for urban furniture and the internals valorisation prestige, includes key, cleaning brush and wall fixing kit.

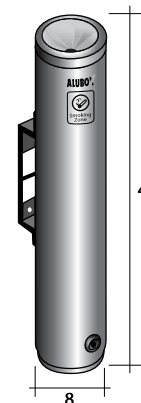



# BACHECHE PORTA AVVISI

Interno



BCN01GH



BCN01BR

## Sportelli in plexiglass

### BACHECHE PORTA AVVISI

Cornice in alluminio anodizzato bronzo o verniciata grigio antracite Ral 7016.

**MOD. BC/1** - (confezione da 2 pezzi)  
cm 30 x 40 x 5 per 1 foglio A4

**MOD. BC/2** - (confezione da 2 pezzi)  
cm 55 x 40 x 5 per 2 fogli A4 o 1 foglio A3

**MOD. BC/5** - (confezione da 1 pezzo)  
cm 55 x 73 x 5 per 4 fogli A4 o 2 fogli A3

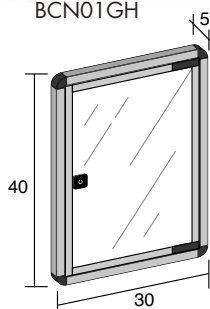

BCN02GH



BCN02BR

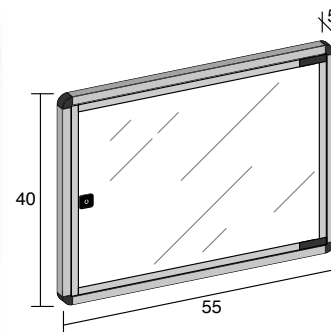

BCN05GH



BCN05BR

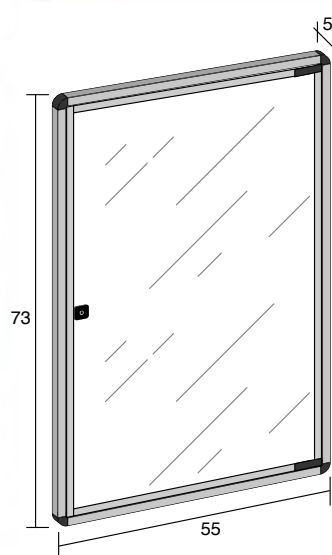

MADE IN CHINA

# BACHECHE PORTA AVVISI CON APERTURA A SCATTO

Interno



SIMPLEX2AR



### BACHECHE PORTA AVVISI

In alluminio anodizzato argento con pratica apertura a scatto. Molto sottile ed elegante, consigliata anche per esporre fotografie.

**MOD. SIMPLEX1AR** - (confezione da 5 pezzi)  
cm 35 x 26 per 1 foglio A4

**MOD. SIMPLEX2AR** - (confezione da 5 pezzi)  
cm 38 x 51 per 2 fogli A4 o 1 foglio A3

### NOTICE BOARDS

In anodized aluminium silver with snap open, very slim suitable to display photos.

**MOD. SIMPLEX1AR** - (5-pieces package)  
35 x 26 cm. Accommodates 1 A4 format sheet.

**MOD. SIMPLEX2AR** - (5-pieces package)  
38 x 51 cm. Accommodates 2 A4 format sheets or 1 A3 format sheet.



SIMPLEX1AR

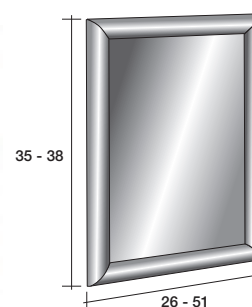

# BACHECHE PORTA CHIAVI

**Interno**

BCN08GH



BCN08BR

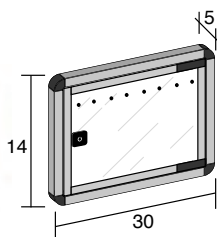

## Sportelli in plexiglass

### BACHECHE PORTA CHIAVI

Cornice in alluminio anodizzato bronzo o verniciata grigio antracite Ral 7016.

**MOD. BC/8 - Per n° 8 chiavi**

(confezione da 6 pezzi)  
cm 30 x 14 x 5

**MOD. BC/16 - Per n° 16 chiavi**

(confezione da 4 pezzi)  
cm 30 x 25 x 5

**MOD. BC/24 - Per n° 24 chiavi**

(confezione da 2 pezzi)  
cm 30 x 40 x 5

**MOD. BC/48 - Per n° 48 chiavi**

(confezione da 2 pezzi)  
cm 55 x 40 x 5

**MOD. BC/96 - Per n° 96 chiavi**

(confezione da 1 pezzo)  
cm 55 x 73 x 5

## Plexiglass doors

### KEY STANDS

Bronze-color anodized aluminium frame or anthracite finish Ral 7016.

**MOD. BC/8 - Accomodates 8 keys**

(6-pieces package)  
30 x 14 x 5 cm

**MOD. BC/16 - Accomodates 16 keys**

(4-pieces package)  
30 x 25 x 5 cm

**MOD. BC/24 - Accomodates 24 keys**

(2-pieces package)  
30 x 40 x 5 cm

**MOD. BC/48 - Accomodates 48 keys**

(2-pieces package)  
55 x 40 x 5 cm

**MOD. BC/96 - Accomodates 96 keys**

(1-piece package)  
55 x 73 x 5 cm



BCN16GH



BCN16BR

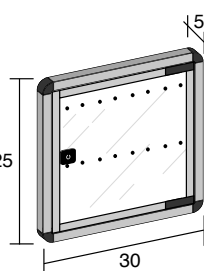

BCN24GH



BCN24BR

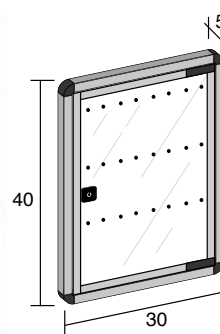

BCN48GH



BCN48BR

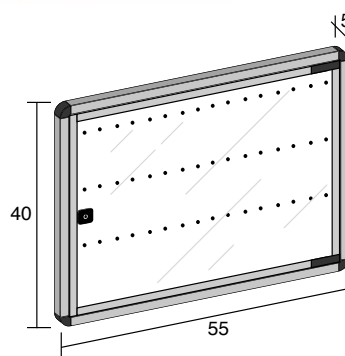

BCN96GH



BCN96BR

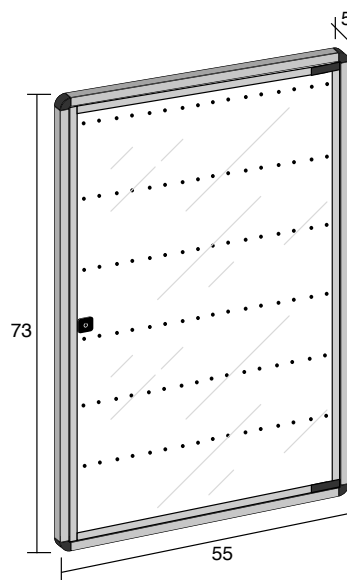

# LUCCHETTO PORTA OGGETTI PORTATILE

Esterno **Interno**

## ad esaurimento



(confezione 6 pezzi)

### LUCCHETTO PORTA OGGETTI PORTATILE

In lega di zinco, può contenere piccoli oggetti di grande valore, senza chiave con combinazione a 4 numeri, ideale per contenere: chiavi di casa, del garage, dell'auto, chiavi di uso comune per condomini, amministratori ed edili, comandi remoti di cancelli automatici, denaro contante, monete, gioielli, orologi da polso, lettori mp3....

(6-pieces package)

### PORTABLE SAFETY BOX

Small safety box, most security, made in zinc alloy material, without key, 4 digit number, suitable to contain small things as : home keys, garage keys, car keys, key for apartment block common use, for property manager or building site, remote control for automatic gates, cash money, coins, jewels, wrist watch, mp3 player....

**Lucchetto**  
Portable safety box

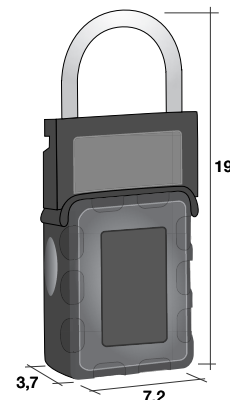

Dimensioni vano interno: Base cm 5,9 - Altezza cm 7,7 - Profondità cm 3.  
Internal dimensions: Width 5,9 cm - Height 7,7 cm - Depth 3 cm.

# APPENDITUTTO



**Interno**

## ad esaurimento



"Tengo"® di Alubox è un appenditutto universale. Veloce, facile da installare e semplice da usare, è realizzato con componenti durevoli, resistenti e leggeri.

La caratteristica di questo nuovo e rivoluzionario sistema, consiste nella capacità di agganciare e sospendere qualsiasi oggetto.

"Tengo"® by Alubox is a universal hanger. Fast, easy to install and simple to use.

"Tengo"® is provided with self-locking sliding fasteners and is made with durable, resistant, lightweight components. The distinctive feature of this new revolutionary system is that it allows you to fasten and hang any kind of object.



Avvitare la rotaia in alluminio al muro o ad una superficie piatta con le viti e i tasselli forniti nel kit. Per sbloccare il corpo scorrevole, ruotare il gancio verso destra.

Fasten the aluminium track to a wall or flat surface using the screws and anchors provided in the kit. To release the sliding part, turn the hook to the right.

Far scorrere i corpi scorrevoli sulla rotaia fino a raggiungere la posizione desiderata.

Move the sliding fasteners along the track until they are in the desired position.

Per bloccare e sospendere l'oggetto far ruotare il gancio verso sinistra riportandolo nella posizione centrale.

To hang the object and lock it in place, turn the hook to the left until it is back in the middle position.

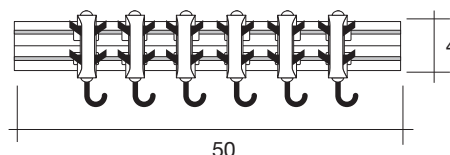

*Esempi Espositivi Personalizzati*  
*Examples of Customized Layout*



# Esempi espositivi personalizzati



# Example of customized layout





Esempio di layout da 1m. - Example of a 1m layout.



Esempio di layout da 2m. - Example of a 2m layout.



Esempio di layout da 3m. - Example of a 3m layout.

Richiedi il tuo Layout personalizzato  
Ask for your customized Layout

## Example of 1m, 2m, 3m and 4m layouts for self-service shops



Esempio di angolo espositivo personalizzato con l'utilizzo di un pannello dipinto a mano in esemplare unico a scelta su soggetti diversi.  
Example of customized exhibition corner using a unique hand painted board to be selected from the range of various subjects available.



Esempio di layout da 4m. - Example of a 4 m layout.



## COLORI DELLE PARTI IN ALLUMINIO ANODIZZATO

### COLORS FOR ANODIZED ALUMINIUM



Anodizzato Argento - Anodized Silver Color



Anodizzato Bronzo - Anodized Bronze Color

## COLORI DELLE PARTI VERNICIATE CASSETTE POSTALI E BACHECHE

### PAINTED PARTS COLORS FOR MAILBOXES AND BOARDS



Bianco RAL 9016 - RAL 9016 White

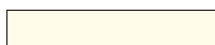

Avorio RAL 1013 - RAL 1013 Ivory



Argento RAL 9006 - RAL 9006 Silver



Nero RAL 9005 - RAL 9005 Black



Verde RAL 6005 - RAL 6005 Green



Rosso RAL 3003 - RAL 3003 Red



Grigio Antracite RAL 7016  
RAL 7016 Anthracite color

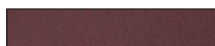

Ruggine - Rust

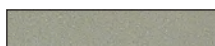

Metallizzato argento - Metallic paint Silver

#### Serie MODULAR

Per colori Ral non in catalogo: se disponibili, aumento del 25% netto sulle parti verniciate (sportelli, mantello, cornice, piantane, placche accessori).

For RAL colors not in catalogue there will be an increase of 25% net on painted parts (doors, casing, frame, column support, intercom panel).

#### Serie CURVE

Colori RAL a richiesta senza alcun supplemento di prezzo, previa disponibilità presso verniciatura.

#### CURVE SERIE

RAL colors on request without additional charge.  
Subject to availability at varnisher.

#### Nota bene:

I colori sono indicativi in quanto la stampa su carta non consente una perfetta riproduzione delle tonalità.

#### Please note:

Color samples are only indicative as printing on paper does not allow the accurate reproduction of the actual color.

## CONDIZIONI GENERALI DI VENDITA SALES TERMS

- IVA esclusa
- Resa: porto franco con addebito in fattura
- Imballo di serie: gratis
- Le quantità dovranno essere uguali o multiple del minimo imballo
- Eventuali disimballi € 6,00 netti.
- Importo minimo fatturabile € 200,00 netti.
- Spese gestione per mancato raggiungimento minimo fatturabile: € 10,00 netti.
  
- **Imballi speciali per serie Modular:**  
a costo netto, come indicato nei preventivi.

- *Prices do not include VAT*
- *Delivery terms: ex works*
- *Standard packing: free of charge*
- *Quantities on order must correspond to or be multiples of the minimum package quantity.*
- *No-standard orders (partial packages)  
€ 6,00 net.*
- *Minimum invoice amount: € 200,00 net.*
- *Extra charge for purchase below minimum amount: € 10,00 net.*
  
- **Special packaging for Modular Series:**  
*at cost, as specified in the estimate.*

Il contenuto di questo catalogo è coperto da diritti d'autore e nulla può essere riprodotto o fotocopiato senza autorizzazione scritta.

*This catalogue is covered by copyright. No part of it shall be reproduced or photocopied without written permission.*

Caratteristiche tecniche ed estetiche non sono impegnative e possono subire modifiche senza preavviso a giudizio della ALUBOX s.r.l. Pianoro - Bologna - Italy

*Technical and styling features are merely indicative. ALUBOX s.r.l. Pianoro (Bologna), Italy reserves the sole right to modify them at any time and without prior notice.*

## AGENTI ITALIA SETTORE FERRAMENTA AGENTS FOR ITALY-HARDWARE SECTOR

### PIEMONTE - VALLE D'AOSTA

#### Francesco Iampietro

Cellulare 335-6770141 - Tel./Fax uff. 011 0133003

e-mail: iampietrofrancesco@gmail.com

#### Gianfranco Stocco

Cellulare 335-5237966 - e-mail: gianfranco.stocco@fiscali.it

### LOMBARDIA

**Pasini Rappresentanze** - Tel. 02-48952193 - Fax 02-4222033

**Pasini Renzo:** Cellulare 335-5456843

**Pasini Giancarlo:** Cellulare 335-5456858

**Pasini Claudio:** Cellulare 335-5718302

e-mail: pasini@parenz.it

### VENETO - TRENTINO

#### R.A.F. DI LONGO MARIO

Mario Longo: 329-4443290 - e-mail: mariolng4@gmail.com

### FRIULI V.G.

**Gianluca Podrecca** 335-8140638

e-mail: gianluca.podrecca@gmail.com

### LIGURIA

**Romiti Lorenzo:** Tel. 010-5959383 - Fax 010-5951650

Cellulare 348-4124231 - e-mail: info@rpritalia.it

### EMILIA ROMAGNA - MARCHE - TOSCANA - UMBRIA

**Ghedini Giorgio & C. s.n.c.**

Tel. 051-6236052 - Fax 051-6235722

Cellulare 339-4048358 - e-mail: ghedini.giorgio@libero.it

### ABRUZZO - MOLISE

#### Ballistreri Mario

Fax 071-714122

Cellulare 349-2550232 - e-mail: mario.b46@libero.it

### LAZIO

**Pompei Rappresentanze s.a.s.**

Tel. 06-2148202 - Fax 06-2148205

**Pompei Herbert:** Cellulare 393-5767219

**Pompei Alessandro:** Cellulare 335-5767217

**Rotoloni Paolo:** Cellulare 335-5767218

e-mail: pompeirap@pompeirap.it

### CAMPANIA

**Cibelli Rappresentanze s.a.s.**

Tel. 081-270910 - Fax 081-271663

**Enzo De Rosa:** Cellulare 338-1527564

e-mail: info@cibellirappresentanze.it

**Scognamiglio Enrico:** Cellulare 335-8415042

e-mail: scognamiglioenrico5@gmail.com

### CALABRIA

**LMGROUP s.a.s.**

Tel./Fax 0984-433487 - e-mail: info@groupm.it

**Stefano Minardi:** 346-7058753 - s.minardi@groupm.it

**Carmine Minardi:** 348-5201646 - c.minardi@groupm.it

**Fortunato Lucia:** 348-5201645 - f.lucia@groupm.it

**Luigi Perri:** 348-5201644 - l.perri@groupm.it

### PUGLIA - BASILICATA

**2R RAPPRESENTANZE**

080-4793283

Raffaele Visicchio - Raffaele Chieco

e-mail: info@2rappresentanze.it

### SICILIA ORIENTALE:

**D'Urso Umberto**

SIRACUSA - RAGUSA - ENNA - CATANIA

Tel. 095-7640233 - Cellulare 337-634632

**Scandura Sandro**

MESSINA E CATANIA

Cellulare 335-6225369 - e-mail: scanduradurso@gmail.com

### SICILIA OCCIDENTALE

**La Bianca Rappresentanze**

PALERMO - TRAPANI - AGRIGENTO - CALTANISSETTA

Tel. 091-8613315 - Fax 091-8670875

**Andrea La Bianca:** Cellulare 338-4214621

e-mail: labirap@gmail.com

### SARDEGNA

**Mainas Alessandro**

Cellulare 334-7353447

e-mail: ale.main@fiscali.it



# ALUBOX

Cassette Postali - Mailboxes  MADE IN ITALY

ALUBOX s.r.l

Via Boaria, 5 - 40065 Pianoro Bologna - Italy - tel. +39 051 743 565 - fax +39 051 744 010  
info@alubox.it - www.alubox.it

SETTEMBRE 2017

**RISTAMPA**  
settembre 2019